

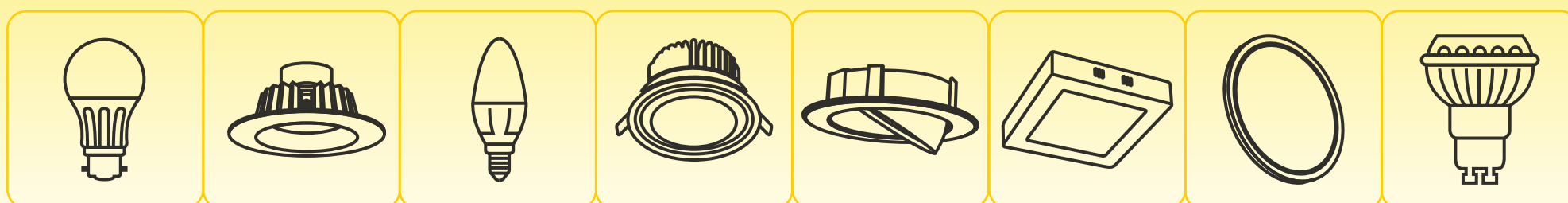

wipro Lighting

Wipro lighting is proud of being one of the most trusted brand in lighting industry. We have continuously focused on embracing the latest and finest technology to deliver highly efficient products for numerous lighting application areas and have always believed in offering our customers the best in class, latest design, environment friendly lighting products and solutions. Our endeavour has also been recognized by some of the most important and influential organizations around the world which reaffirms our right approach towards leadership, technological innovation, customer service & strategic product development.



WIPRO LED ADVANTAGES



Superior Quality LED Chip with LM 80 Tested LED Technology

Low lumen depreciation

No color change

Ensures long life



Designed for Indian Condition

Wide input voltage range 150-300VAC

High voltage protection upto 380VAC

Surge protection upto 2.5KV



High Quality Optics

High efficiency non yellowing diffuser

Antiglare design with LGP technology

Safe for eyes



Efficient Heat Management

Aluminum heat sink for better heat dissipation.

Low LED soldering temperature

Long life assured.

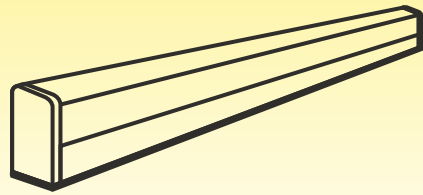

GARNET LED LIGHTING RANGE



SMART HOME



SMART PRODUCTS

Control your smart products via Wipro Next App in your smart phone and through voice control like Amazon Alexa or Google Assistant. Download the "Wipro Next Smart Home" app from the Apple App Store or Google Play Store. Now choose from 16 million color shades and light up your moments with different shades of Wipro smart LED bulb. Set the brightness to any level, schedule a timer and create light group as desired.



GARNET SMART BULB

- Create your ambience with 16mn color & white tunable options
- Smoothly change brightness of lights from 100% to 10%
- Control your light from anywhere with Wipro Next Smart App
- Voice control lights through amazon alexa and google assistant
- Set timer to automatically turn on/off lights using schedule function
- Create different group of lights to operate it together
- The lights are operated directly through 2.4hz Wi-Fi without hub



 **16 Million Color**

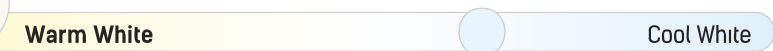

 **White Tunable**

Warm White  Cool White

 **Dimmable Lights**

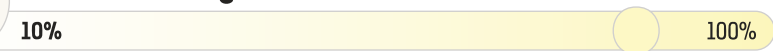
10%  100%





Base Cap



Base Cap

CAT NO	WATTAGE(W)	CCT(K)	BASECAP
NS9400	9	(2700-6500) + RGB	B22
NS9100	9	(2700-6500)	B22
NS9500	9	(2700-6500) + RGB	E27
NS1220	12.5	(2700-6500) + RGB	B22



 **Download Wipro Next Smart Home App**   App Store & Play Store



APPLICATIONS



BED ROOM



LIVING ROOM



KITCHEN



PARKING

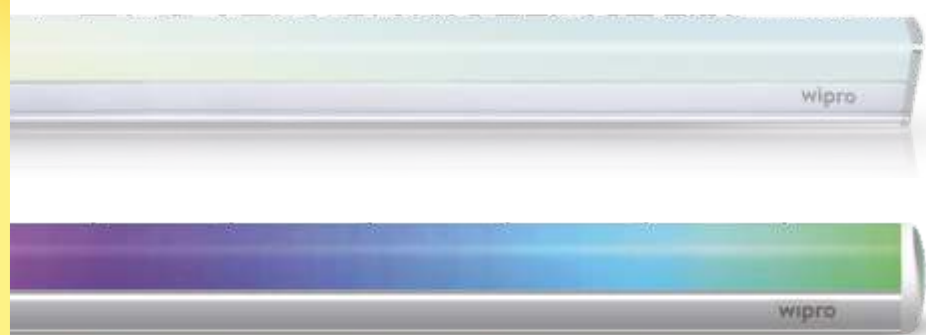

GARNET SMART BATTEN



- › Create your ambience with 16mn color & white tunable options
- › Smoothly change brightness of lights from 100% to 10%
- › Control your light from anywhere with Wipro Next Smart App
- › Voice control lights through amazon alexa and google assistant
- › Set timer to automatically turn on/off lights using schedule function
- › Create different group of lights to operate it together
- › The lights are operated directly through 2.4hz Wi-Fi without hub

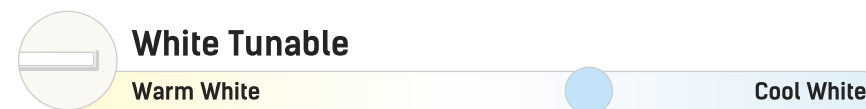

CAT NO	WATTAGE (W)	CCT (K)	VOLTAGE RANGE (VAC)
DS12000	20	(6500-2700)	220-240
DS22000	20	(6500-2700)+RGB	220-240

DIMENSIONS

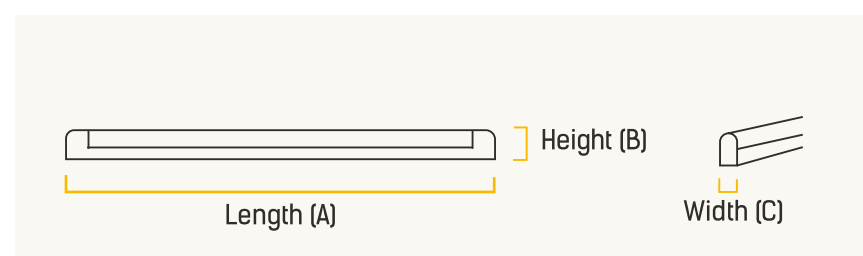

WATTAGE (W)	LENGTH (A)	HEIGHT (B)	WIDTH (C)
20 (CCT)	1136 mm	38 mm	55 mm
20 (CCT+RGB)	900 mm	34 mm	45 mm



APPLICATIONS



BED ROOM



LIVING ROOM



KITCHEN



PARKING

GARNET SMART DOWNLIGHTS

The new generation Wipro Smart Panels can change color and brightness through Wipro Next Smart Home. It helps to set the mood of occasion by changing color and also saves energy by controlling the brightness as per the requirement.



MOOD LIGHTING

Change Color between 2700K and 6500K to create right ambience



DIMMABLE

Set Brightness of Panels from 100% to 10% as per requirement



VOICE CONTROL

Control lights with your voice after connecting it to internet via Gateway

Set the right light for the right mood

BRIGHT

DIM

BRIGHT COOL WHITE



BRIGHT NUETRAL WHITE



BRIGHT WARM WHITE



WARM WHITE



COOL WHITE

WARM WHITE

GARNET SMART TRIMLESS COB



- Create ambience with white tunable smart cob comes with trimless and compact design perfect for your smart home
- Smoothly change brightness of lights from 100% to 10%.
- Control lights from anywhere in the world with Wipro App*
- Wipro Bluetooth Mesh Gateway required to connect lights to internet.
- Voice control lights through amazon alexa and google assistant*
- Create different group lights to operate them together

*After lights are connected to Internet via sigmesh gateway

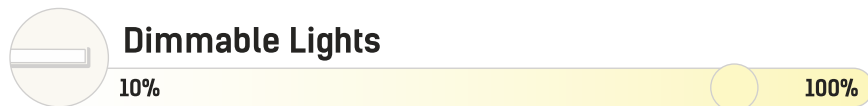

CAT NO	WATTAGE(W)	CCT(K)	VOLTAGE RANGE(VAC)
DS50610	06	2700-6500	150-300
DS51010	10	2700-6500	150-300
DS51510	15	2700-6500	150-300

DIMENSIONS



WATTAGE(W)	DIAMETER(A)	HEIGHT(B)	CUTOUT(C)∅	BEAM ANGLE(°)
06	60 mm	65 mm	50 mm	24°
10	82 mm	73 mm	75 mm	24°
15	82 mm	73 mm	75 mm	24°

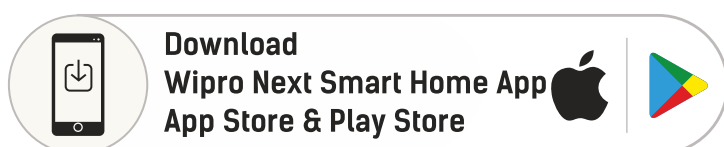

APPLICATIONS





GARNET SMART MODULE COB



- Create ambiance with white tunable Smart cob
- Smoothly change brightness of lights from 100% to 10%.
- Control lights from anywhere in the world with Wipro App*
- Wipro Bluetooth Mesh Gateway required to connect lights to internet.
- Voice control lights through amazon alexa and google assistant*
- Create different group lights to operate them together

*After lights are connected to Internet via sigmesh gateway

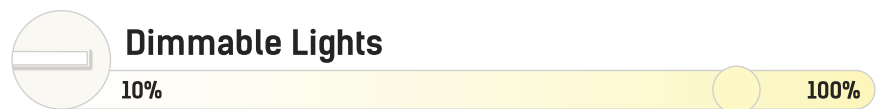

CAT NO	WATTAGE(W)	LUMENS(lm)	CCT(K)	VOLTAGE RANGE(VAC)
DS51000	10	800	2700-6500	150-300
DS51500	15	1200	2700-6500	150-300

WATTAGE(W)	DIAMETER(A)	HEIGHT(B)	BEAM ANGLE(°)
10	80 mm	80 mm	25°
15	80 mm	80 mm	25°



APPLICATIONS

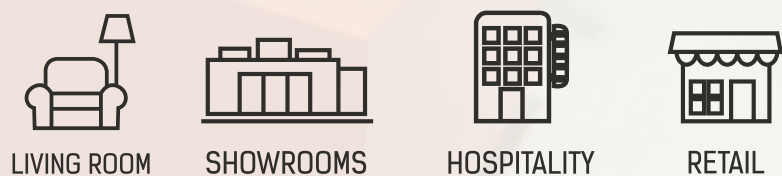

LIVING ROOM

SHOWROOMS

HOSPITALITY

RETAIL



GARNET SMART PANEL



- ▷ Create ambiance with white tunable Smart panel
- ▷ Smoothly change brightness of lights from 100% to 10%
- ▷ Control lights from anywhere in the world with Wipro App*
- ▷ Wipro Bluetooth Mesh Gateway required to connect lights to internet
- ▷ Voice control lights through amazon alexa and google assistant*
- ▷ Create different group of lights to operate them together

*After lights are connected to Internet via sigmesh gateway

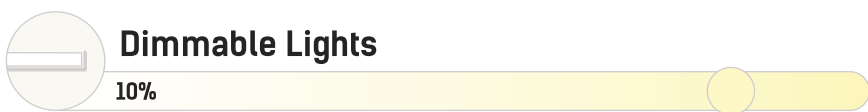

CAT NO	WATTAGE (W)	CCT (K)	VOLTAGE RANGE(VAC)
DS40600	06	6500-2700	220-240
DS31200	12	6500-2700	220-240
DS41800	18	6500-2700	220-240

DIMENSIONS

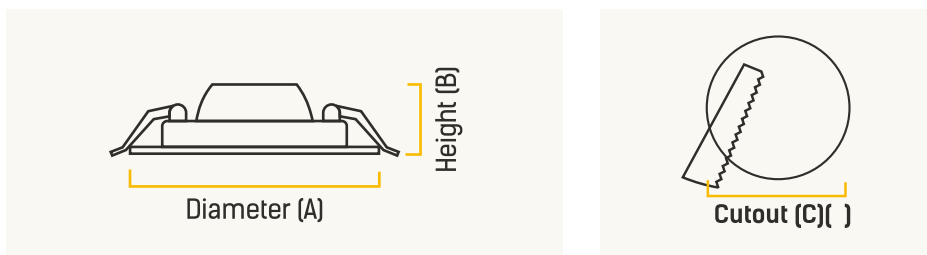

WATTAGE (W)	DIAMETER (A)	HEIGHT (B)	CUTOUT (C)
06	120 mm	20 mm	108 mm
12	170 mm	20 mm	160 mm
18	225 mm	20 mm	210 mm

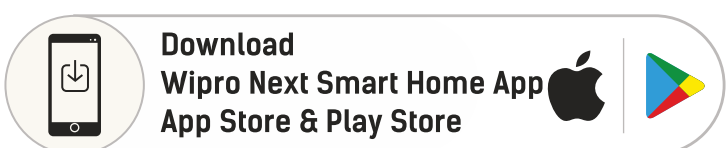
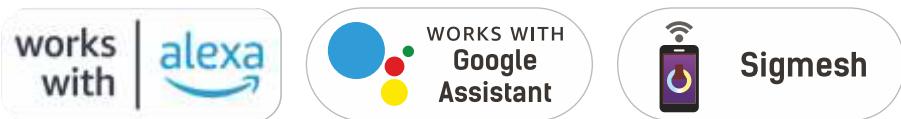

APPLICATIONS



GARNET SMART STRIP LIGHT



- ↳ Create your ambience with 16mn color & white tunable options
- ↳ Smoothly change brightness of lights from 100% to 10%
- ↳ Control your light from anywhere with Wipro Next Smart App
- ↳ Voice control lights through amazon alexa and google assistant
- ↳ Set timer to automatically turn on/off lights using schedule function
- ↳ Create different group of lights to operate it together
- ↳ The lights are operated directly through 2.4hz Wi-Fi without hub

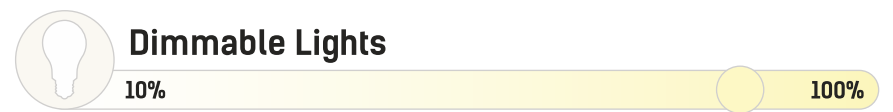
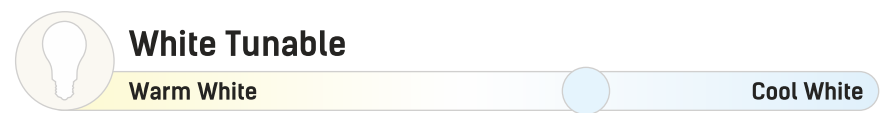

CAT NO	WATTAGE (W/5 mtr)	VOLTAGE (DC)
DS44000	40W	24



GARNET COLOR CHANGING LIGHTS

COOL DAY WHITE

6500K

Energise your room with vibrant shades from Cool White lighting.

NEUTRAL WHITE

4000K

Let your interiors look pleasant with Neutral White lighting.

WARM WHITE

2700K

Add a warm and relaxing atmosphere to your space with Warm White lighting.



1 Light 3 Modes

A tri colour LED Batten that changes the ambience of your room to suit your mood. It's three shades of white complement your room at different times of the day.

GARNET WAVE COLOR CHANGING PANEL



- ↳ Changes color between 2700K to 6500K with click of switch
- ↳ Trimless design for seamless merge with ceiling
- ↳ LM 80 tested LED technology ensures long life
- ↳ Driver with high voltage protection of 440V
- ↳ Surge protection upto 4.KV



CAT NO	WATTAGE(W)	CCT(K)	VOLTAGE RANGE(VAC)
DG30600	06	6500/4000/2700	150-300
DG31000	10	6500/4000/2700	150-300
DG31500	15	6500/4000/2700	150 300



DIMENSIONS

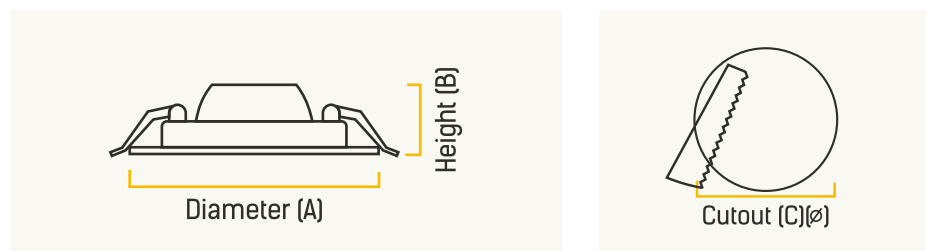

WATTAGE (W)	SIZE (A)	HEIGHT (B)	CUTOUT (C)(∅)
06	116 mm	32 mm	100 mm
10	145 mm	32 mm	130 mm
15	166 mm	32 mm	150 mm

* Lumen for 6500K



APPLICATIONS



BED ROOM



LIVING ROOM



OFFICE

GARNET WAVE COLOR CHANGING PANEL



- ↳ Changes color between 2700K to 6500K with click of switch
- ↳ Trimless design for seamless merge with ceiling
- ↳ LM 80 tested LED technology ensures long life
- ↳ Driver with high voltage protection of 440V
- ↳ Surge protection upto 4.KV



Warm White



Neutral White



Cool White

CAT NO	WATTAGE(W)	CCT(K)	VOLTAGE RANGE(VAC)
DG40600	06	6500/4000/2700	150-300
DG41000	10	6500/4000/2700	150-300
DG41500	15	6500/4000/2700	150 300



TURN OFF AND ON
IN 3 SECONDS
TO CHANGE COLOR

DIMENSIONS

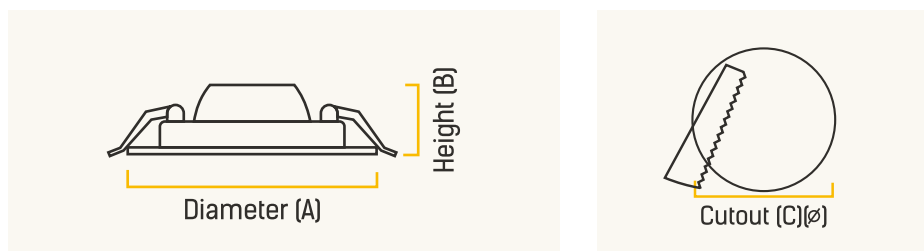

WATTAGE (W)	SIZE (A)	HEIGHT (B)	CUTOUT (C)(ø)
06	116 mm	116 mm	100 mm
10	145 mm	145 mm	130 mm
15	166 mm	166 mm	150 mm

* Lumen for 6500K



APPLICATIONS



BED ROOM



LIVING ROOM



OFFICE

GARNET COB



New generation COB LED technology, with an innovative adjustable optics to focus light on desired areas. Great color & light quality adds value to your products & merchandise by enhancing their looks & appeal.

GARNET COB



- Industry best lumen output with efficacy more than 100lm/W
- Reflector & clear optics to create sharp light beam without glare
- Adjustable design to focus light on desired area
- Aluminium heat sink for better heat dissipation
- LM 80 tested LED technology ensures long life
- Driver with high voltage protection upto 380VAC
- Surge protection upto 2.5 KV



CAT NO	WATTAGE(W)	CCT(K)	LUMENS(Lm)	VOLTAGE RANGE(VAC)
DC10365	3	6500	210	150-300
DC10340	3	4000	205	150-300
DC10327	3	2700	200	150-300
DC10665	6	6500	490	150-300
DC10640	6	4000	480	150-300
DC10627	6	2700	470	150-300
DC10965	9	6500	860	150-300
DC10940	9	4000	850	150-300
DC10927	9	2700	790	150-300
DC11265	12	6500	1100	150-300
DC11240	12	4000	1050	150-300
DC11227	12	2700	1040	150-300
DC11665	16	6500	1620	150-300
DC11640	16	4000	1540	150-300
DC11627	16	2700	1500	150-300
DC12465	24	6500	2360	150-300
DC12440	24	4000	2350	150-300
DC12427	24	2700	2180	150-300
DC13065	30	6500	2500	150-300
DC13040	30	4000	2450	150-300
DC13027	30	2700	2400	150-300

DIMENSIONS

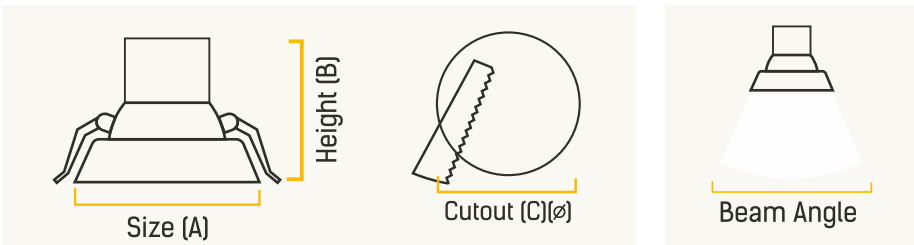

WATTAGE (W)	SIZE (A)	HEIGHT (B)	CUTOUT (C)(Ø)	BEAM (°)
3	66 mm	30 mm	55 mm	38°
6	81 mm	40 mm	65 mm	38°
9	90 mm	50 mm	75 mm	38°
12	98 mm	55 mm	85 mm	38°
16	110 mm	65 mm	90 mm	38°
24	145 mm	84 mm	135 mm	38°
30	165 mm	90 mm	145 mm	38°



APPLICATIONS





GARNET TRIMLESS COB



- ▷ Trimless & compact design seamlessly merges with the ceiling
- ▷ Antiglare optics with deep reflector design
- ▷ Aluminium heat sink for better heat dissipation
- ▷ Sharp light cone effect on wall for wall washer application
- ▷ LM 80 tested LED technology ensures long life
- ▷ Driver with high voltage protection upto 380VAC.
- ▷ Surge protection upto 2.5 KV



Warm White



Neutral White



Cool White

CAT NO	WATTAGE(W)	CCT(K)	LUMENS(lm)	VOLTAGE RANGE(VAC)
DC20665	6	6500	530	150-300
DC20640	6	4000	525	150-300
DC20627	6	2700	510	150-300
DC20965	9	6500	830	150-300
DC20940	9	4000	810	150-300
DC20927	9	2700	780	150-300
DC21565	15	6500	1230	150-300
DC21540	15	4000	1220	150-300
DC21527	15	2700	1210	150-300



DIMENSIONS

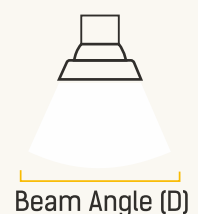
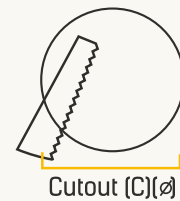
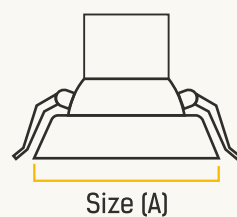

WATTAGE (W)	SIZE (A)	HEIGHT (B)	CUTOUT (C)(Ø)	BEAM (°)
6	50 mm	53 mm	45 mm	60°
9	70 mm	64 mm	65 mm	40°
15	78 mm	76 mm	73 mm	40°

APPLICATIONS



MODERN HOMES



SHOWROOMS



HOSPITALITY



RETAIL



GARNET COMPACT COB



- Ultra compact & trimless design, seamless merge with ceiling
- Aluminium heat sink for better heat dissipation
- Deep reflector optics to provide glare free light
- Very sharp & intense light beam to highlight wall & objects
- LM 80 tested LED technology ensures long life
- Driver with high voltage protection upto 380VAC
- Surge protection upto 2.5 KV



Warm White



Neutral White

CAT NO	WATTAGE(W)	CCT(K)	LUMENS(lm)	VOLTAGE RANGE(VAC)
DC40540	5	4000	390	150-300
DC40527	5	2700	370	150-300
DC41240	12	4000	950	150-300
DC41227	12	2700	860	150-300



DIMENSIONS

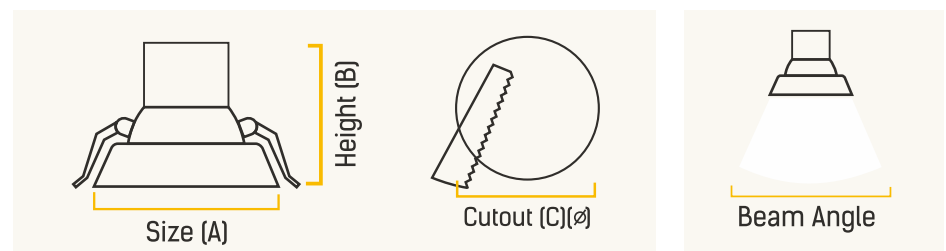

WATTAGE (W)	SIZE (A)	HEIGHT (B)	CUTOUT (C)(∅)	BEAM (°)
5	46 mm	59 mm	40 mm	55°
12	60 mm	82 mm	55 mm	40°

APPLICATIONS



MODERN HOMES



SHOWROOMS



HOSPITALITY



RETAIL

GARNET TRIMLESS COB GOLD



- Premium black housing with Rose Gold Reflector
- Trimless & compact design seamlessly merges with the ceiling
- Deep reflector optics to create sharp light beam without glare
- Sharp light cone effect on wall for wall washer
- LM 80 tested LED technology ensures long life
- Driver with high voltage protection upto 380VAC
- Surge protection upto 2.5 KV



Warm White



Neutral White

CAT NO	WATTAGE (W)	CCT (K)	LUMENS (lm)	VOLTAGE RANGE(VAC)
DC30940	9	4000	740	150-300
DC30927	9	2700	710	150-300
DC31540	15	4000	1230	150-300
DC31527	15	2700	1180	150-300



DIMENSIONS

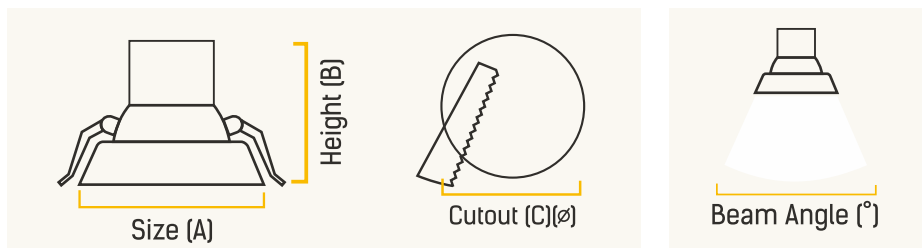

WATTAGE (W)	SIZE (A)	HEIGHT (B)	CUTOUT (C)(ø)	BEAM (°)
9	75 mm	64 mm	65 mm	40°
15	85 mm	76 mm	75 mm	38°



APPLICATIONS



GARNET COMPACT COB GOLD



- Ultra compact design with rose gold reflector
- Aluminium heat sink for better heat dissipation
- Deep reflector optics to provide glare free light
- Very sharp & intense light beam to highlight wall & objects
- LM 80 tested LED technology ensures long life
- Driver with high voltage protection upto 380VAC
- Surge protection upto 2.5 KV



Warm White



Neutral White

CAT NO	WATTAGE(W)	CCT(K)	LUMENS(lm)	VOLTAGE RANGE(VAC)
DC50540	5	4000	390	150-300
DC50527	5	2700	380	150-300
DC51240	12	4000	850	150-300
DC51227	12	2700	820	150-300



DIMENSIONS

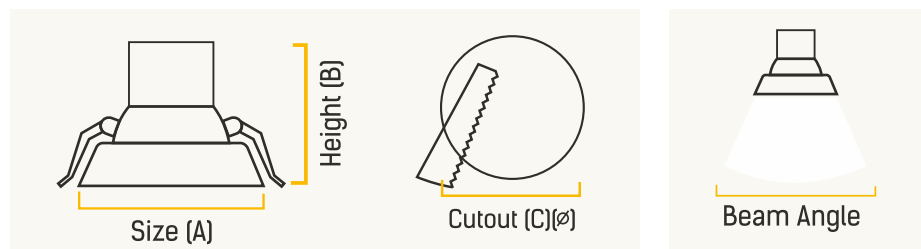

WATTAGE (W)	SIZE (A)	HEIGHT (B)	CUTOUT (C)(ø)	BEAM (°)
5	46 mm	59 mm	40 mm	45°
12	60 mm	82 mm	55 mm	15°



APPLICATIONS





GARNET TRIMLESS BLACK COB



- LM80 tested COB technology
- Wide voltage range 150-300 VAC
- Driver with 2.5 kV surge protection
- Wide voltage protection upto 380V
- Anti-glare design with deep optics



Warm White



Neutral White



Cool White

CAT NO	WATTAGE(W)	CCT(K)	LUMENS(lm)	VOLTAGE RANGE(VAC)
DC60640	6	4000	470	150-300
DC60627	6	2700	460	150-300
DC60940	9	4000	730	150-300
DC60927	9	2700	710	150-300
DC61540	15	4000	1170	150-300
DC61527	15	2700	1160	150-300

DIMENSIONS

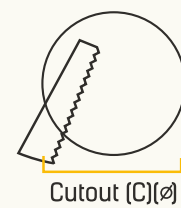
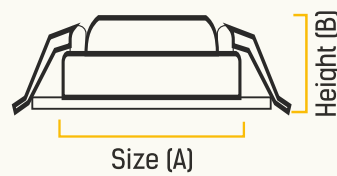

WATTAGE (W)	SIZE (A)	SIZE (B)	CUTOUT (C)(∅)	BEAM (°)
6	50 mm	53 mm	45	60°
9	71 mm	65 mm	65	36°
15	78 mm	82 mm	75	36°

APPLICATIONS



MODERN HOMES



SHOWROOMS



HOSPITALITY



RETAIL



GARNET

ARCHITECTURAL MODULAR COB SPOTLIGHT



- Modular COB spotlight with adjustable design
- Sharp light beam with reflector optics to focus light on desirable areas
- LM 80 tested LED technology ensures long life of LED Chips
- Aluminum die cast design ensures good heat dissipation
- Driver has up to 380 VAC high voltage protection
- 2.5 KV surge protection

CAT NO	WATTAGE (W)	CCT (K)	LUMEN(Lm)	VOLTAGE RANGE (VAC)
DE10527	05	2700	425	150-300
DE10540	05	4000	475	150-300
DE11027	10	2700	750	150-300
DE11040	10	4000	850	150-300



DIMENSIONS

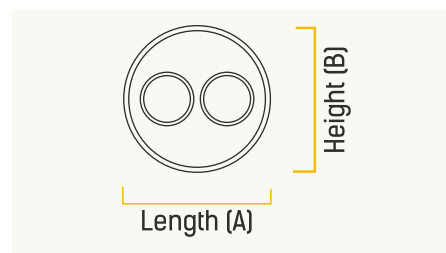

WATTAGE (W)	LENGTH (A)	HEIGHT (B)	CUTOUT	BEAM ANGLE (°)
05	74mm	63mm	68	36°
10	107 mm	64 mm	100	36°

APPLICATIONS



LIVING ROOM



SHOWROOM



BEDROOM

GARNET LINEAR COB



- ▷ Deep reflector optics to provide glare free light
- ▷ Linear design with very sharp and high intensity LED chip
- ▷ LM80 tested LED technology for long life
- ▷ Aluminium heat sink for better heat dissipation
- ▷ Surge protection upto 2.5kV



Warm White



Neutral White

CAT NO	WATTAGE(W)	CCT(K)	LUMENS(lm)	VOLTAGE RANGE(VAC)
DC71040	10	4000	800	220-240
DC71027	10	2700	800	220-240
DC72040	20	4000	1600	220-240
DC72027	20	2700	1600	220-240

DIMENSIONS

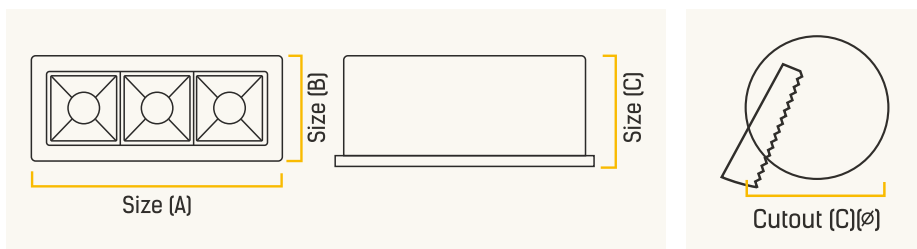

WATTAGE (W)	SIZE (A)	SIZE (B)	SIZE (C)	CUTOUT
10	147 mm	44 mm	31 mm	141 x 36 mm
20	280 mm	44 mm	31 mm	274 x 36 mm

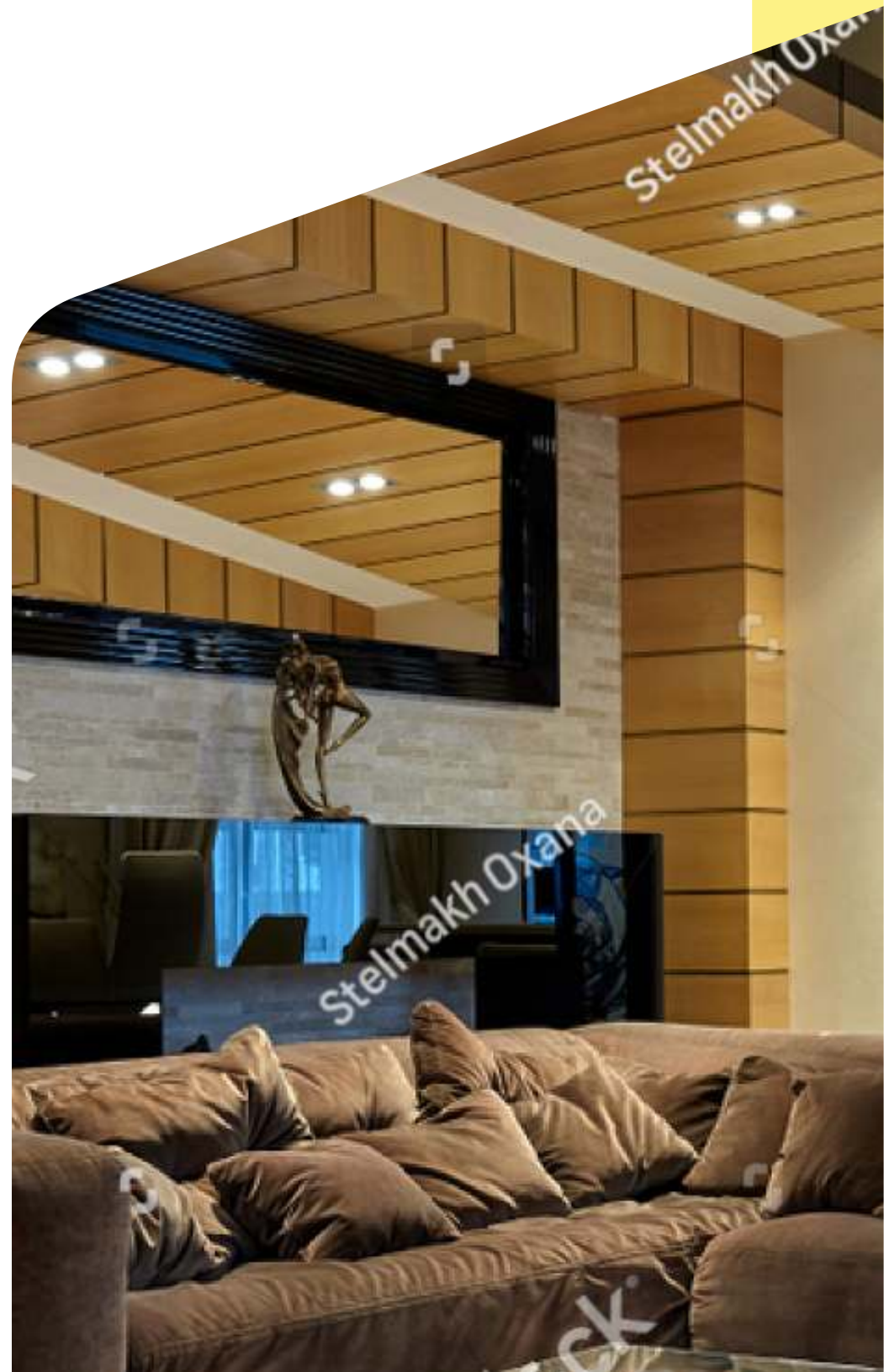

APPLICATIONS

- MODERN HOMES
- SHOWROOMS
- HOSPITALITY
- RETAIL

GARNET PENDENT COB



- ↳ LM 80 Tested LED Technology Ensures long life
- ↳ Wide voltage range 150-300VAC
- ↳ Sharp Beam Angle with COB chip and reflector optics
- ↳ Driver with 380V high voltage and 2.5kV surge Protection
- ↳ Good thermal design with Aluminum Housing
- ↳ No UV or IR radiation



2700K
Warm White



6500K
Cool White



CAT NO	WATTAGE(W)	CCT(K)	LUMENS (lm)	DIMENSIONS	CASE LOT
DK11040	10	4000	650	55X154 mm	10
DK11027	10	2700	630	75X155 mm	10
DK11540	15	4000	1380	55X154 mm	10
DK11527	15	2700	1360	75X155 mm	10

SURFACE COB



- ↳ LM 80 Tested LED Technology Ensures long life
- ↳ Wide voltage range 150-300VAC
- ↳ Sharp Beam Angle with COB chip and reflector optics
- ↳ Driver with 380V high voltage and 2.5kV surge Protection
- ↳ Good thermal design with Aluminum Housing
- ↳ No UV or IR radiation



CAT NO	WATTAGE(W)	CCT(K)	LUMENS (lm)	DIMENSIONS	CASE LOT
DK21540	15	4000	1380	75X155mm	10
DK21527	15	2700	1360	75X155mm	10



APPLICATIONS

KITCHEN

LIVING ROOM



GARNET SLIM COB SPOTLIGHTS



- ↳ Slimmest spotlights (20mm), easily used in low depth false ceilings
- ↳ Aluminium PDC heat sink for effective heat dissipation
- ↳ Dual optics technology for better light distribution
- ↳ Adjustable design to focus light on desired area
- ↳ LM 80 tested LED technology ensures long life
- ↳ High voltage protection upto 380VAC
- ↳ Surge protection upto 2.5KV



Warm White



Neutral White



Cool White

CAT NO	WATTAGE(W)	CCT(K)	LUMENS(lm)	VOLTAGE RANGE(VAC)
D320365	3	6500	230	150-300
D320340	3	4000	220	150-300
D320327	3	2700	210	150-300
D320665	6	6500	520	150-300
D320640	6	4000	510	150-300
D320627	6	2700	500	150-300
D320965	9	6500	720	150-300
D320940	9	4000	710	150-300
D320927	9	2700	700	150-300

DIMENSIONS

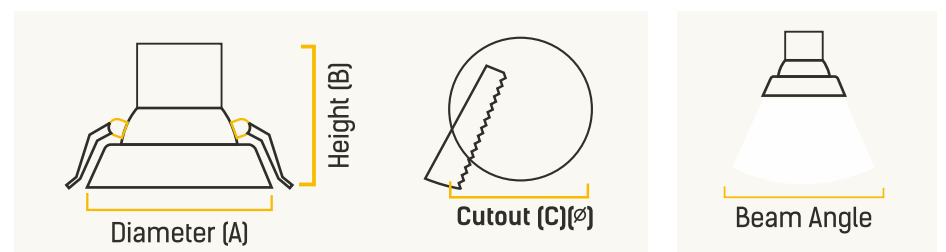

WATTAGE (W)	DIAMETER (A)	HEIGHT (B)	CUTOUT (C)(∅)	BEAM (°)
3	72 mm	20 mm	62 mm	38°
6	82 mm	20 mm	72 mm	38°
9	87 mm	20 mm	77 mm	38°

APPLICATIONS



BED ROOM



LIVING ROOM



KITCHEN



GARNET WAVE SPOTLIGHT



- Adjustable Design to focus light on desired area
- LM 80 tested LED Technology for better life
- Sharp light beam angle of 45° gives brighter light
- High Voltage protection upto 440VAC
- Surge protection upto 4KV



Warm White



Neutral White



Cool White

CAT NO	WATTAGE(W)	CCT(K)	LUMENS(lm)	VOLTAGE RANGE(VAC)
DG50365	3	6500	225	150-300
DG50340	3	4000	210	150-300
DG50327	3	2700	195	150-300
DG50665	6	6500	480	150-300
DG50640	6	4000	450	150-300
DG50627	6	2700	420	150-300
DG50965	9	6500	720	150-300
DG50940	9	4000	675	150-300
DG50927	9	2700	630	150-300
DG51265	12	6500	960	150-300
DG51240	12	4000	900	150-300
DG51227	12	2700	840	150-300



DIMENSIONS

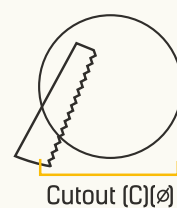
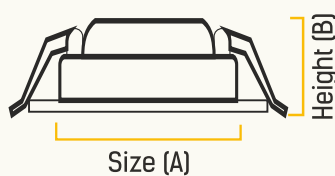

WATTAGE (W)	DIAMETER (A)	HEIGHT (B)	CUTOUT (C)(∅)	BEAM (°)
3	75X75	43	60	60°
6	95X95	46	75	60°
9	116X116	52	100	60°
12	139X139	55	125	60°

APPLICATIONS



MODERN HOMES



SHOWROOMS



HOSPITALITY



RETAIL



GARNET MINI SPOTLIGHTS



- Compact cob spotlight with adjustable design
- Reflector optics to create sharp light beam
- LM 80 tested LED technology ensures long life
- Driver with high voltage protection upto 380VAC
- Surge protection upto 2KV

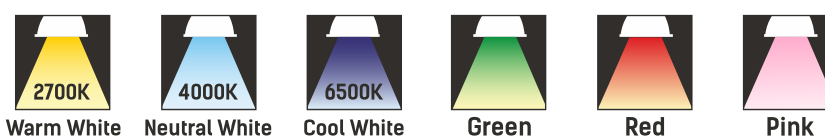

CAT NO	WATTAGE(W)	CCT(K)	LUMENS(lm)	VOLTAGE RANGE(VAC)
D340365	3	6500	260	150-300
D340327	3	2700	240	150-300
D340380	3	BLUE	-	150-300
D340395	3	GREEN	-	150-300
D340390	3	RED	-	150-300
D340385	3	PINK	-	150_300



DIMENSIONS

WATTAGE (W)	SIZE (A)	HEIGHT (B)	CUTOUT (C)(∅)	BEAM (°)
3	75 mm	45 mm	58 mm	45°

APPLICATIONS



DECORATION



SHELF



FOCUS



CABINET

GARNET 2W SPOTLIGHT



- ↳ Compact design with 17 mm height, ideal for shelf lighting
- ↳ Aluminium heat sink for better heat dissipation
- ↳ Lens optics to create sharp light cone without glare
- ↳ LM 80 tested LED technology ensures long life
- ↳ Integrated driver with high voltage protection upto 380V
- ↳ Surge protection upto 2.5 KV



CAT NO	WATTAGE(W)	CCT(K)	LUMENS (lm)	VOLTAGE RANGE(VAC)
D740265	2	6500	95	150-300
D740227	2	2700	95	150-300
D740280	2	BLUE		150-300
DT40290	2	RED		150-300
D740295	2	GREEN		150-300
D740285	2	PINK		150-300



DIMENSIONS

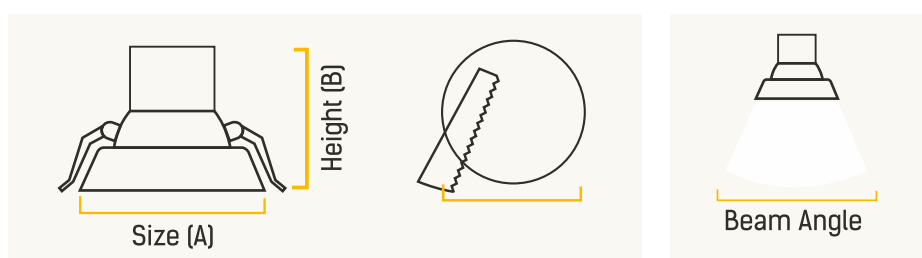

WATTAGE (W)	SIZE (A)	HEIGHT (B)	CUTOUT (C)(∅)	BEAM (°)
2	42 mm	17 mm	33 mm	60



APPLICATIONS



GARNET DOWNLIGHTS



An exquisite range of LED downlighters, with the best light output in the industry. It is simple to install due to its integrated design and comes with IP44 protection (resistant to dust and water splashes).

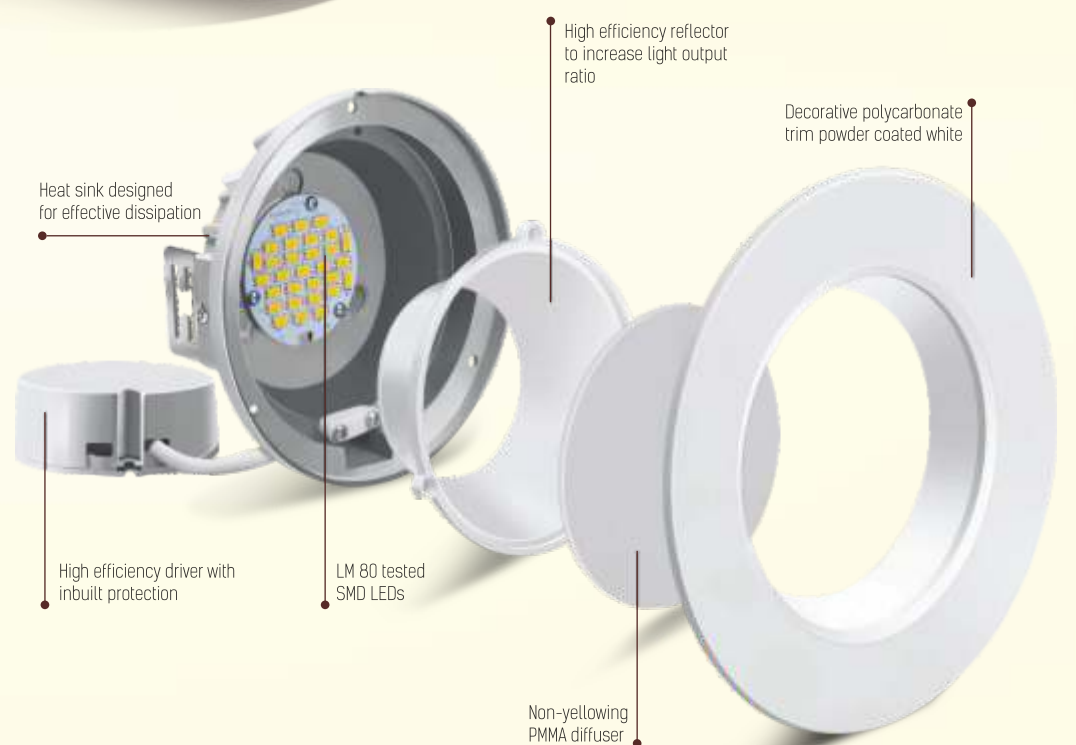



GARNET DOWNLIGHT



- ▷ Decorative design with aluminium PDC housing
- ▷ Industry best lumen efficacy upto 110lm/W
- ▷ High efficiency non yellowing polycarbonate diffuser
- ▷ Deep down optics for glare free light
- ▷ LM 80 tested LED technology ensures long life
- ▷ Driver with HV protection upto 380V & surge protection upto 2.5KV



2700K
Warm White



4000K
Neutral White



6500K
Cool White

CAT NO	WATTAGE(W)	CCT(K)	LUMENS(lm)	VOLTAGE RANGE(VAC)
D731060	10	6000	1000	150-300
D731040	10	4000	980	150-300
D731030	10	3000	950	150-300
D731560	15	6000	1500	150-300
D731540	15	4000	1450	150-300
D731530	15	3000	1425	150-300
D742060	20	6000	2200	150-300
D742040	20	4000	2100	150-300
D742030	20	3000	2000	150-300

DIMENSIONS

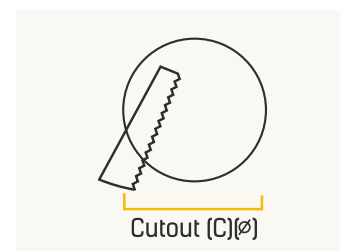
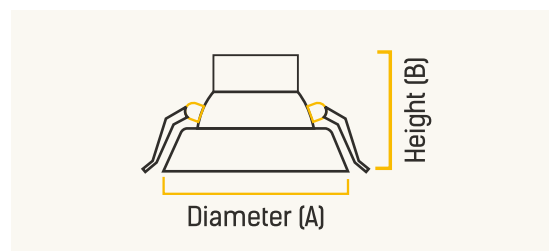

WATTAGE (W)	SIZE (A)	HEIGHT (B)	CUTOUT (C)(∅)
10	118 mm	51 mm	100 mm
15	148 mm	52 mm	125 mm
20	178 mm	56.5 mm	150 mm

APPLICATIONS



MODERN HOMES



OFFICES



SHOWROOMS



LOBBY

GARNET WAVE ROUND DOWNLIGHTS



- Premium and compact design
- Aluminium heat sink for better heat dissipation
- Polycarbonate diffuser for glare free light
- LM 80 tested SMD LED technology
- Integrated driver with high voltage protection upto 380VAC
- IP 44 protection against dust and moisture



Warm White



Neutral White



Cool White

CAT NO	WATTAGE (W)	CCT (K)	LUMENS (lm)	VOLTAGE RANGE (VAC)
D540565	5	6500	440	150-300
D540540	5	4000	420	150-300
D540527	5	2700	400	150-300
D540865	8	6500	720	150-300
D540840	8	4000	700	150-300
D540827	8	2700	650	150-300
D541265	12	6500	1100	150-300
D541240	12	4000	1050	150-300
D541227	12	2700	1000	150-300
D541565	15	6500	1400	150-300
D541540	15	4000	1360	150-300

DIMENSIONS

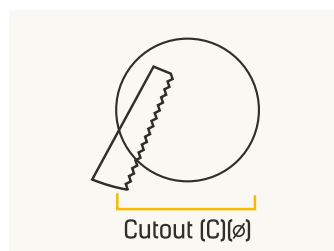
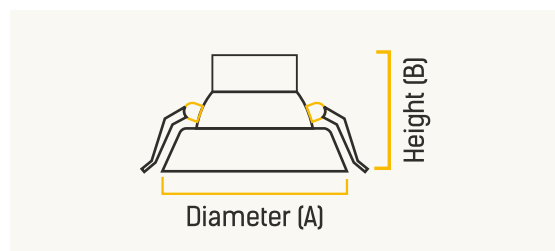

WATTAGE (W)	DIAMETER (A)	HEIGHT (B)	CUTOUT (C)(ϕ)
5	95 mm	58 mm	70 mm
8	113 mm	59 mm	94 mm
12	145 mm	66 mm	125 mm
15	174 mm	68 mm	150 mm



APPLICATIONS



GARNET ROUND DOWNLIGHT (JUNCTION BOX)



- ↳ LM80 tested LED technology ensures long life
- ↳ High Brightness design with 100lm/W efficacy*
- ↳ Wide Voltage Range 150-300 VAC
- ↳ Driver with 440V high voltage and 4kV surge protection
- ↳ Glare free light quality with diffuser optics



Warm White



Neutral White

CAT NO	WATTAGE(W)	CCT(K)	LUMENS(lm)	VOLTAGE RANGE(VAC)
D520865	8	6500	800	150-300
D520840	8	4000	800	150-300
D520827	8	2700	720	150-300
D520880	8	BLUE	-	150-300
D520890	8	RED	-	150-300
D520895	8	GREEN	-	150-300



DIMENSIONS

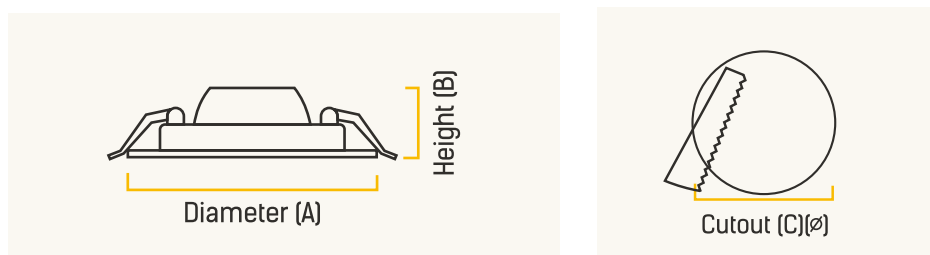

WATTAGE (W)	SIZE (A)	HEIGHT (B)	CUTOUT (C)(∅)
5	110 mm	48 mm	75 mm
7	110 mm	48 mm	75 mm
8	110 mm	48 mm	75 mm



APPLICATIONS



BED ROOM



LIVING ROOM



RETAIL



GARNET MINI DOWNLIGHTS



- Compact design suitable for 2 inch junction boxes
- High efficiency and non yellowing polycarbonate diffuser
- 120 degree wide beam angle for uniform lighting
- LM 80 tested LED technology ensures long life
- Driver with high voltage protection upto 440VAC
- Surge protection upto 2.5KV



Warm White



Cool White

CAT NO	WATTAGE(W)	CCT(K)	LUMENS(lm)	VOLTAGE RANGE(VAC)
D350365	3	6500	180	150-300
D350327	3	2700	170	150-300
D350865	8	6500	640	140-300
D350827	8	2700	560	140-300
D351565	15	6500	1275	140-300



DIMENSIONS

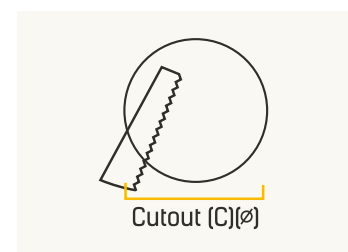
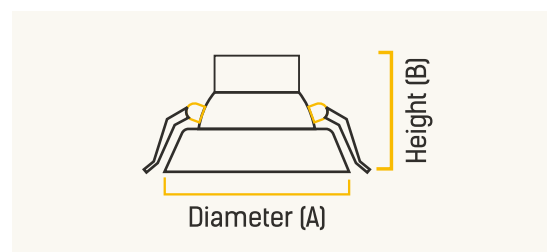

WATTAGE (W)	SIZE (A)	HEIGHT (B)	CUTOUT (C)(∅)
3	80 mm	44 mm	60 mm
8	83 mm	66 mm	60 mm
15	140 mm	70 mm	60 mm

APPLICATIONS



MODERN HOMES



SHOWROOMS



RETAIL



GARNET INDOOR WALL LIGHT WITH 360 Degree Light



- ↻ Premium design with dual light effect
- ↻ Adjustable 3W spotlight for bedside reading
- ↻ 6W indirect for leisure or relaxation
- ↻ LM 80 Tested LED Technology with CREE LED Chip provides long life
- ↻ Robust design with aluminum body
- ↻ Driver designed with 380V high voltage
- ↻ 2.5kv Surge protection

CAT NO	WATTAGE(W)	CCT(K)	VOLTAGE RANGE(VAC)
DW10927	09	2700	150-300



APPLICATIONS

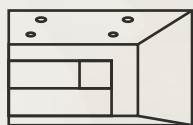

INDOOR

DIMENSIONS

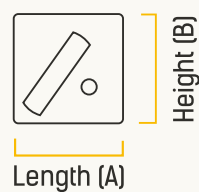

WATTAGE (W)	LENGTH (A)	HEIGHT (B)	WIDTH (C)
09	130mm	130mm	75mm

GARNET INDOOR WALL LIGHT WITH INDIRECT UPLIGHT



- Premium design with dual light effect
- Adjustable 3W spotlight for bedside reading
- 6W indirect Up light effect for leisure or relaxation
- LM 80 Tested LED Technology with CREE LED Chip provides long life
- Robust design with aluminum body
- Driver designed with 380V high voltage
- 2.5kv Surge protection



CAT NO	WATTAGE(W)	CCT(K)	VOLTAGE RANGE(VAC)
DW20927	09	2700	150-300

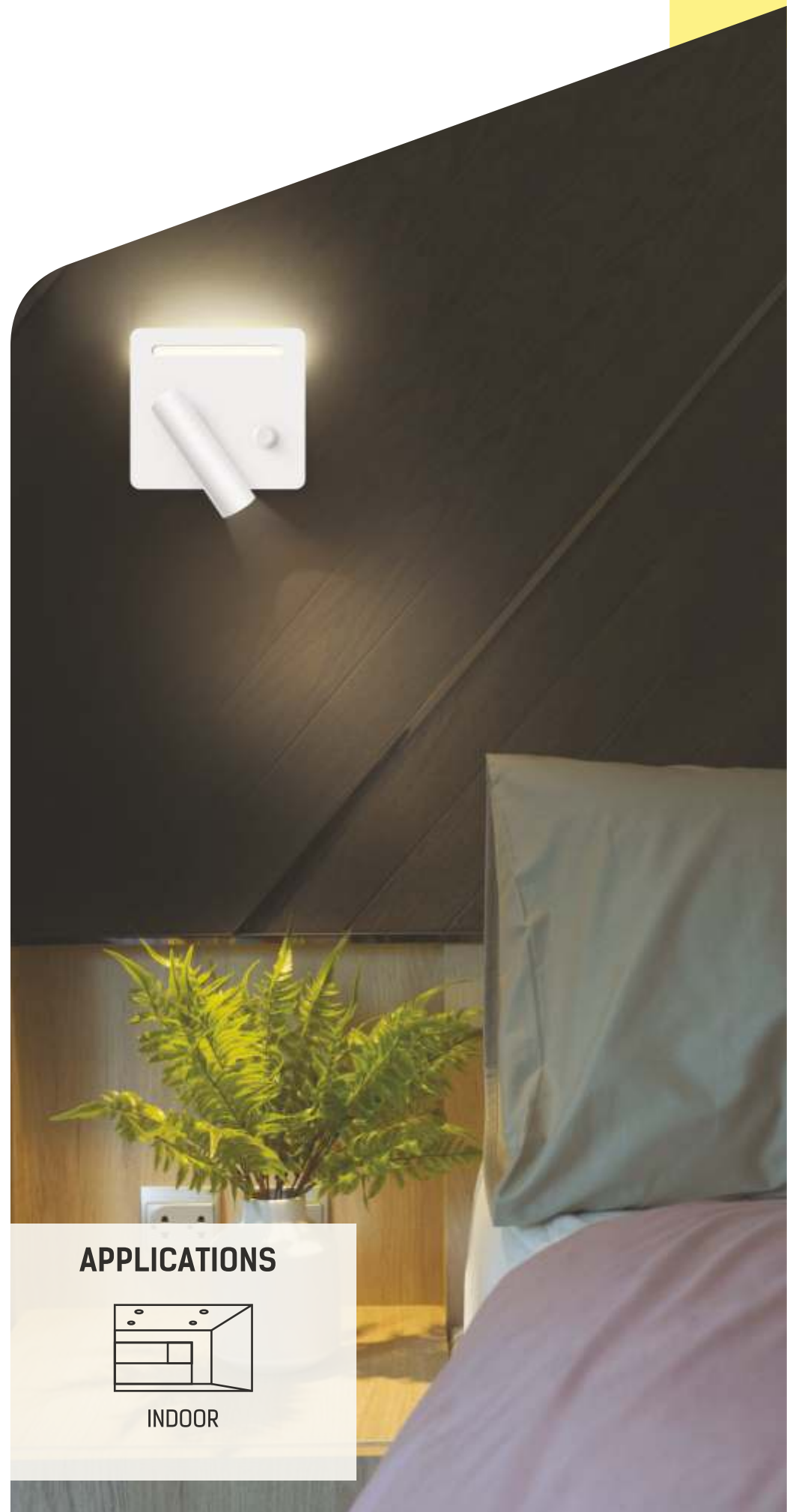

DIMENSIONS



WATTAGE (W)	LENGTH (A)	HEIGHT (B)	WIDTH (C)
09	160mm	150mm	90mm

APPLICATIONS

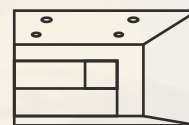

INDOOR



GARNET INDOOR WALL LIGHT WITH USB PORT



- Smart design with Mobile holder & inbuilt USB to recharge mobiles
- 3W adjustable spotlight for reading purpose
- 6W indirect Up light for leisure or relaxation
- LM 80 Tested LED Technology with CREE LED Chip
- Robust design with aluminum body
- Driver designed with 380V high voltage protection
- 2.5kv Surge protection

CAT NO	WATTAGE(W)	CCT(K)	VOLTAGE RANGE(VAC)
DW10627	06	2700	150-300



APPLICATIONS

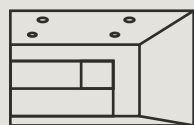

INDOOR

DIMENSIONS

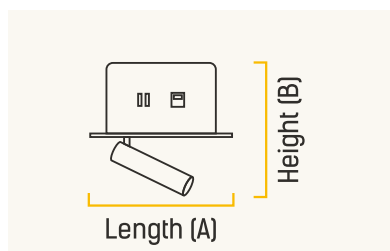

WATTAGE (W)	LENGTH (A)	HEIGHT (B)	WIDTH (C)
06	150mm	120mm	140mm

GARNET

IP54 Wall Light



- Premium design with stylish look in Aluminium housing
- Symmetric up and down light beam for wall decoration
- LM 80 tested LED technology for long life
- Surge protection upto 2.5KV
- IP54 protection for outdoor application



CAT NO	WATTAGE(W)	CCT(K)	VOLTAGE RANGE(VAC)
DW31227	2x6W	2700	150-300



DIMENSIONS

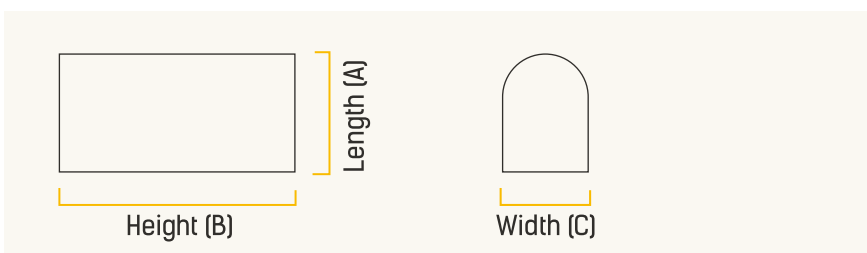

WATTAGE (W)	LENGTH (A)	HEIGHT (B)	WIDTH (C)
2x6W	80 mm	150 mm	68 mm



APPLICATIONS



OUTDOOR WALL LIGHT



GARNET

IP54 UD Wall Light



- Premium design with stylish look in Aluminium housing
- Symmetric up and down light beam for wall decoration
- LM 80 tested LED technology for long life
- Surge protection upto 2.5KV
- IP54 protection for outdoor application

CAT NO	WATTAGE (W)	CCT (K)	VOLTAGE RANGE (VAC)
DW21227	2x6W	2700	150-300



DIMENSIONS

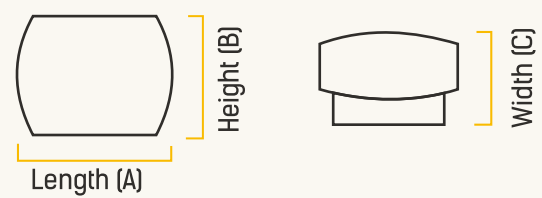

WATTAGE (W)	LENGTH (A)	HEIGHT (B)	WIDTH (C)
2x6W	135 mm	98 mm	60 mm

APPLICATIONS



OUTDOOR WALL LIGHT

GARNET IP54 UD Wall Light



- Premium design with stylish look in Aluminium housing
- Symmetric up and down light beam for wall decoration
- LM 80 tested LED technology for long life
- Surge protection upto 2.5KV
- IP54 protection for outdoor application



CAT NO	WATTAGE(W)	CCT(K)	VOLTAGE RANGE(VAC)
DW11227	2x6W	2700	150-300



DIMENSIONS

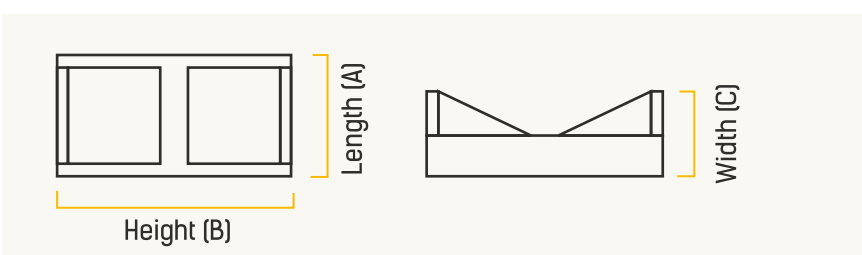

WATTAGE (W)	LENGTH (A)	HEIGHT (B)	WIDTH (C)
2x6W	81 mm	142 mm	66 mm



APPLICATIONS



OUTDOOR WALL LIGHT



GARNET IP54 Wall Light



- Premium design with stylish look in Aluminium housing
- Assymmetric up and down light beam for wall decoration
- LM 80 tested LED technology for long life
- Surge protection upto 2.5KV
- IP54 protection for outdoor application

CAT NO	WATTAGE (W)	CCT (K)	VOLTAGE RANGE (VAC)
DW10827	8W	2700	150-300



DIMENSIONS

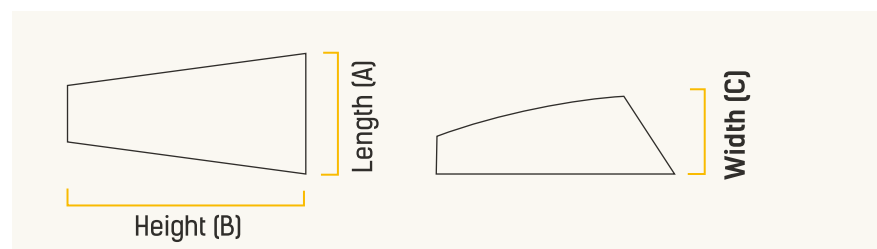

WATTAGE (W)	LENGTH (A)	HEIGHT (B)	WIDTH (C)
2x6W	81 mm	170 mm	48 mm

APPLICATIONS



OUTDOOR WALL LIGHT



GARNET IP54 Wall Light



- Premium design with stylish look in Aluminium housing
- Unidirectional down light beam for wall decoration
- LM 80 tested LED technology for long life
- Surge protection upto 2.5KV
- IP54 protection for outdoor application



CAT NO	WATTAGE(W)	CCT(K)	VOLTAGE RANGE(VAC)
DW20627	6W	2700	150-300



DIMENSIONS

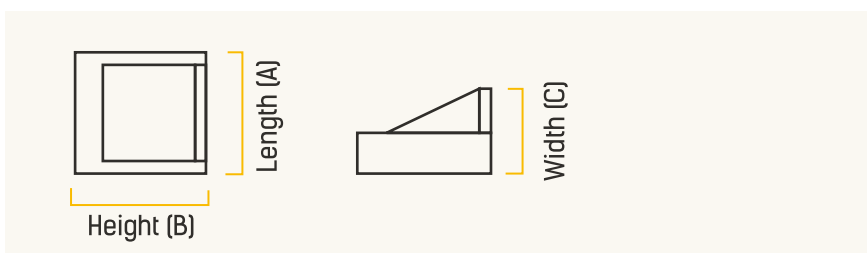

WATTAGE (W)	LENGTH (A)	HEIGHT (B)	WIDTH (C)
2x6W	80 mm	75 mm	66 mm



APPLICATIONS



OUTDOOR WALL LIGHT



GARNET IP54 UD Wall Light



- Premium design with stylish look in Aluminium housing
- Symmetric up and down light beam for wall decoration
- LM 80 tested LED technology for long life
- Surge protection upto 2.5KV
- IP54 protection for outdoor application

CAT NO	WATTAGE(W)	CCT(K)	VOLTAGE RANGE(VAC)
DW30627	2x3W	2700	150-300



DIMENSIONS

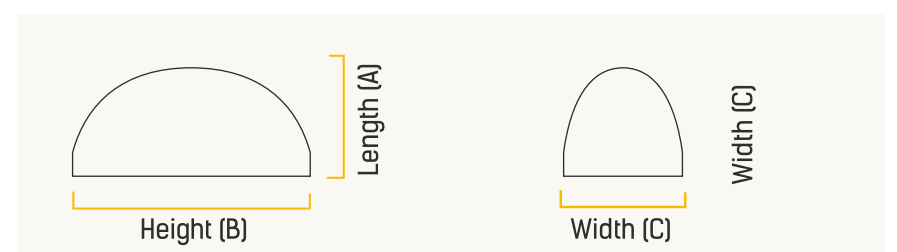

WATTAGE (W)	LENGTH (A)	HEIGHT (B)	WIDTH (C)
2x3W	100 mm	161 mm	78 mm

APPLICATIONS



OUTDOOR WALL LIGHT



GARNET STEP LIGHT IP20



- ↳ Compact design with aluminum die cast housing
- ↳ Indirect light optics provides glare free light
- ↳ LM80 tested LED technology gives long life to LED Chips
- ↳ Driver designed with high voltage protection up-to 380V
- ↳ Surge protection upto 2.5KV
- ↳ IP20 protection for indoor usage



CAT NO	WATTAGE(W)	CCT(K)	LUMENS(lm)	VOLTAGE RANGE(VAC)
DW10327	03	2700	150	150-300



DIMENSIONS

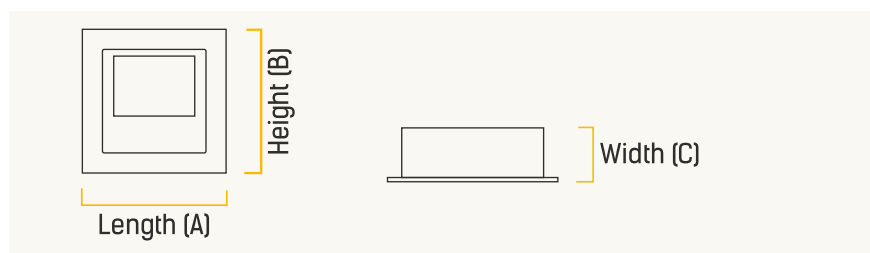

WATTAGE (W)	LENGTH (A)	HEIGHT (B)	WIDTH (C)
03	84 mm	84 mm	40 mm



APPLICATIONS

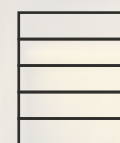

STAIR CASES

GARNET PANEL LIGHTS



The range of ultra slim panels with edge-lit LED's that provide soft, energy efficient light which is used for ambient lighting (indoor applications). It imparts a sense of luxury, with its classic design, aesthetics and quality light.

GARNET

Wave Infinity Round Panel Light



- Rimless design with large light emitting area
- High brightness design with upto 110 Lm/W Efficacy
- LM80 tested LED technology gives long life to LED Chips.
- Glare free light quality with diffuser optics good for eyes
- Driver designed with high voltage protection up-to 440VAc.
- Surge protection upto 4KV



Warm White



Neutral White



Cool White

CAT NO	WATTAGE(W)	CCT(K)	LUMENS(lm)	VOLTAGE RANGE(VAC)
DG10627	6	2700	480	150-300
DG10640	6	4000	510	150-300
DG10665	6	6500	540	150-300
DG11027	10	2700	900	150-300
DG11040	10	4000	950	150-300
DG11065	10	6500	1000	150-300
DG11527	15	2700	1425	150-300
DG11540	15	4000	1500	150-300
DG11565	15	6500	1650	150-300
DG12027	20	2700	1900	150-300
DG12040	20	4000	2000	150-300
DG12065	20	6500	2200	150-300

DIMENSIONS

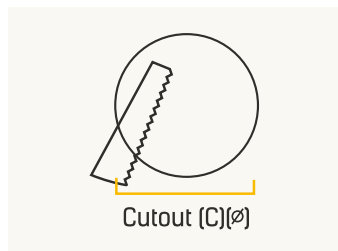
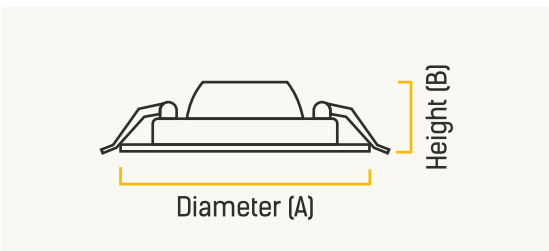

WATTAGE (W)	DIAMETER (A)	HEIGHT (B)	CUTOUT (C)(∅)
6	116 mm	32 mm	100 mm
10	145 mm	32 mm	130 mm
15	166 mm	32 mm	150 mm
20	220 mm	32 mm	205 mm



APPLICATIONS



BED ROOM



LIVING ROOM



KITCHEN



GARNET

Wave Infinity Square Panel Light



- ↳ Rimless design with large light emitting area
- ↳ High brightness design with upto 110 Lm/W Efficacy
- ↳ LM80 tested LED technology gives long life to LED Chips.
- ↳ Glare free light quality with diffuser optics good for eyes
- ↳ Driver designed with high voltage protection up-to 440VAc.
- ↳ Surge protection upto 4KV



Warm White



Neutral White



Cool White

CAT NO	WATTAGE(W)	CCT(K)	LUMENS(lm)	VOLTAGE RANGE(VAC)
DG20627	6	2700	480	150-300
DG20640	6	4000	510	150-300
DG20665	6	6500	540	150-300
DG21027	10	2700	900	150-300
DG21040	10	4000	950	150-300
DG21065	10	6500	1000	150-300
DG21527	15	2700	1425	150-300
DG21540	15	4000	1500	150-300
DG21565	15	6500	1650	150-300
DG22027	20	2700	1900	150-300
DG22040	20	4000	2000	150-300
DG22065	20	6500	2200	150-300

DIMENSIONS

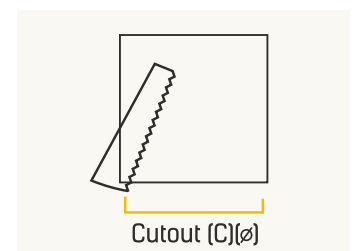
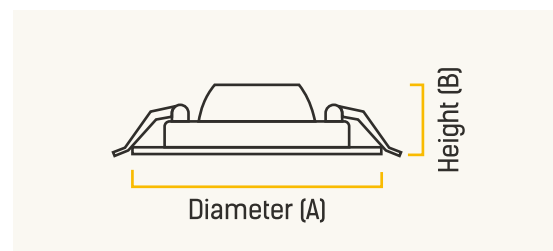

WATTAGE (W)	SIZE (A)	HEIGHT (B)	CUTOUT (C)(ø)
6	116X116 mm	32 mm	100X100 mm
10	145X145 mm	32 mm	130X130 mm
15	166X166 mm	32 mm	150X150 mm
20	220X220 mm	32 mm	205X205 mm

APPLICATIONS



BED ROOM



LIVING ROOM



KITCHEN

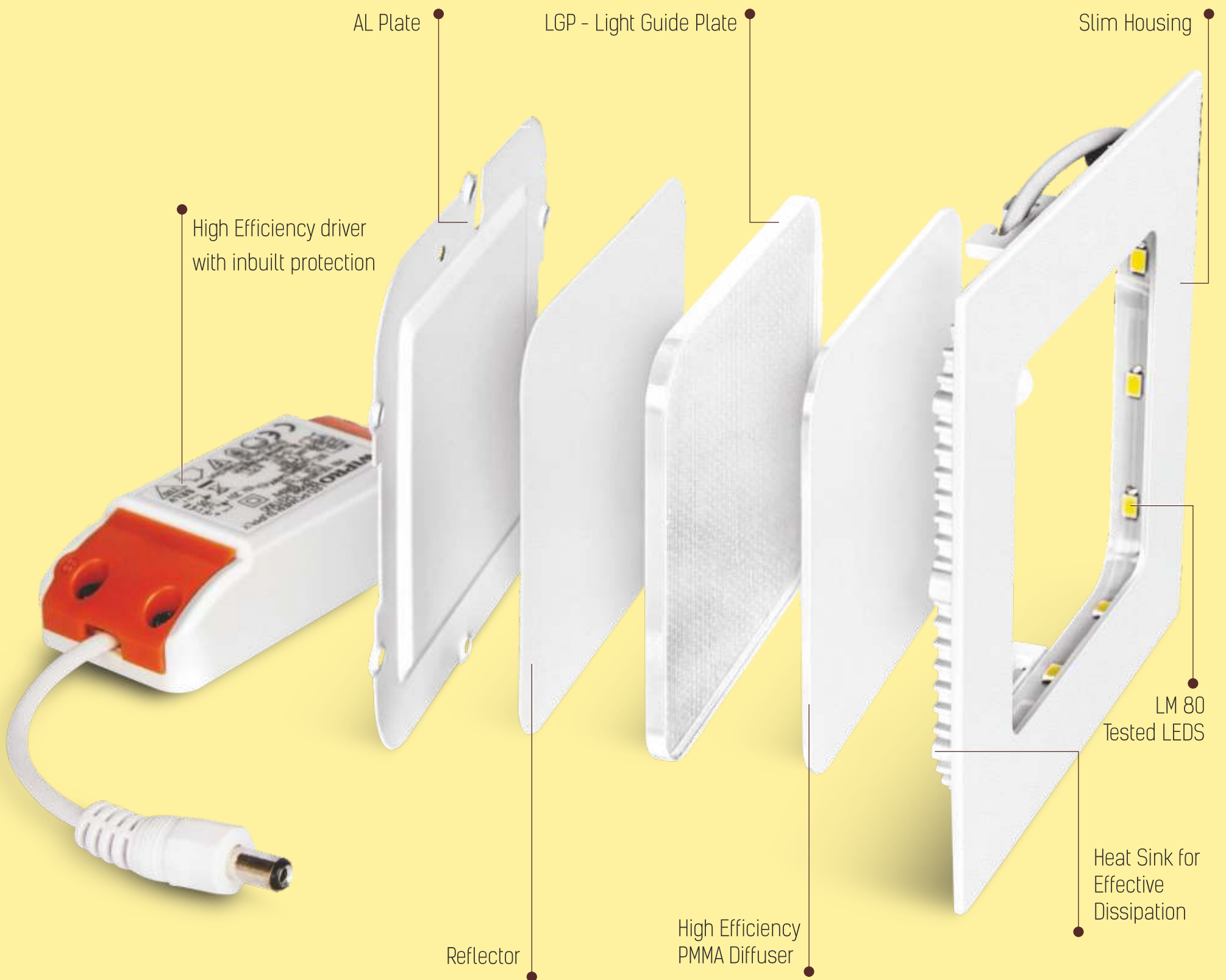

LM 80 tested LED Technology



Designed for Indian Condition 150-300VAC



Antiglare design, safe for eyes



Efficient heat management

GARNET SQUARE PANEL LIGHT



- Robust design with Aluminium die cast body
- Good heat dissipation ensures longer life
- Anti glare LGP technology, safe for eyes
- LM 80 tested LED technology ensures long life
- High voltage protection upto 380 VAC
- Surge protection upto 3.5KV
- Suitable for commercial as well as industrial application



Warm White



Neutral White



Cool White



CAT NO	WATTAGE(W)	CCT(K)	LUMENS(lm)	VOLTAGE RANGE(VAC)
DI20340	3	4000	195	150-300
DI20365	3	6500	210	150-300
DI20327	3	2700	180	150-300
DI20665	6	6500	420	150-300
DI20640	6	4000	390	150-300
DI20627	6	2700	360	150-300
DI30965	9	6500	720	150-300
DI30940	9	4000	675	150-300
DI30927	9	2700	630	150-300
DI21265	12	6500	1200	150-300
DI21240	12	4000	1140	150-300
DI21227	12	2700	1080	150-300
DI31665	16	6500	1800	150-300
DI31640	16	4000	1680	150-300
DI31627	16	2700	1600	150-300
DI12465	24	6500	2400	150-300

DIMENSIONS

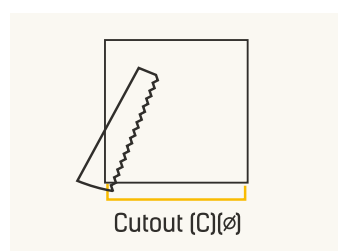
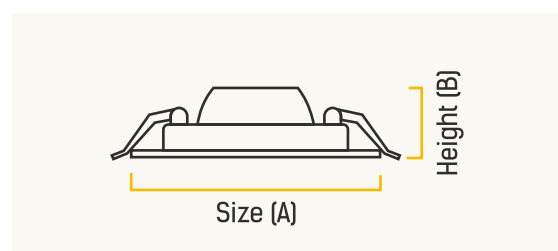

WATTAGE (W)	SIZE (A)	HEIGHT (B)	CUTOUT (C)(∅)
3	82x82 mm	20 mm	70x70 mm
6	120x120 mm	20 mm	104x104 mm
9	152x152 mm	20 mm	128x128 mm
12	172x172 mm	20 mm	153x153 mm
16	190x190 mm	20 mm	173x173 mm
24	300x300 mm	20 mm	280x280 mm



APPLICATIONS

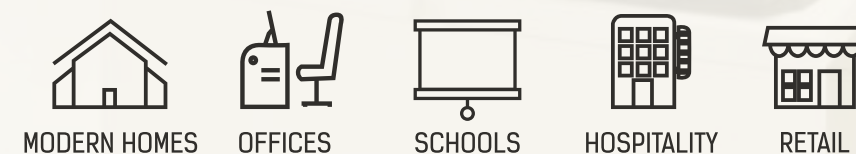



GARNET ROUND PANEL LIGHT



- Robust design with Aluminium die cast body
- Good heat dissipation ensures longer life
- Anti glare LGP technology, safe for eyes
- LM 80 tested LED technology ensures long life
- High voltage protection upto 380 VAC
- Surge protection upto 3.5KV
- Suitable for commercial as well as industrial application



Warm White



Neutral White



Cool White

CAT NO	WATTAGE(W)	CCT(K)	LUMENS(lm)	VOLTAGE RANGE(VAC)
DI10340	3	4000	195	150-300
DI10365	3	6500	210	150-300
DI10327	3	2700	180	150-300
DI10665	6	6500	420	150-300
DI10640	6	4000	390	150-300
DI10627	6	2700	360	150-300
DI20965	9	6500	720	150-300
DI20940	9	4000	675	150-300
DI20927	9	2700	630	150-300
DI11265	12	6500	1200	150-300
DI11240	12	4000	1140	150-300
DI11227	12	2700	1080	150-300
DI21665	16	6500	1600	150-300
DI21640	16	4000	1520	150-300
DI21627	16	2700	1440	150-300

DIMENSIONS

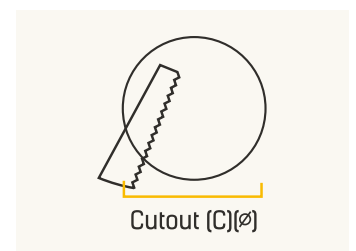
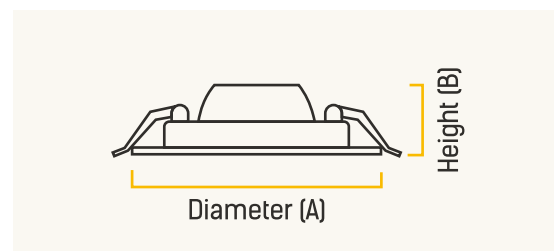

WATTAGE (W)	DIAMETER (A)	HEIGHT (B)	CUTOUT (C)(∅)
3	82 mm	20 mm	78 mm
6	120 mm	20 mm	108 mm
9	152 mm	20 mm	135 mm
12	172 mm	20 mm	155 mm
16	190 mm	20 mm	176 mm

APPLICATIONS



MODERN HOMES



OFFICES



SCHOOLS



HOSPITALITY



RETAIL

GARNET WAVE SLIM ROUND PANEL LIGHT



- ▷ Brightest edge lit panels with efficacy upto 100lm/W
- ▷ Slim and decorative design adds to home décor
- ▷ Aluminium heat sink for effective heat dissipation
- ▷ Anti glare LGP technology, safe for eyes
- ▷ LM 80 tested SMD LED technology
- ▷ Integrated driver with high voltage protection upto 380VAC
- ▷ Surge protection upto 2.5 KV



Warm White



Neutral White



Cool White



CAT NO	WATTAGE(W)	CCT(K)	LUMENS(lm)	VOLTAGE RANGE(VAC)
D710360	3	6000	237	150-300
D710340	3	4000	225	150-300
D710330	3	3000	213	150-300
D710660	6	6000	487	150-300
D710640	6	4000	462	150-300
D710630	6	3000	438	150-300
D711060	10	6000	965	150-300
D711040	10	4000	937	150-300
D711030	10	3000	890	150-300
D711560	15	6000	1468	150-300
D711540	15	4000	1425	150-300
D711530	15	3000	1353	150-300
D712060	20	6000	2058	150-300
D712040	20	4000	1960	150-300
D712030	20	3000	1862	150-300

DIMENSIONS

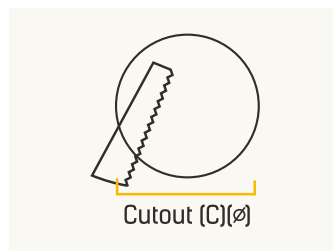
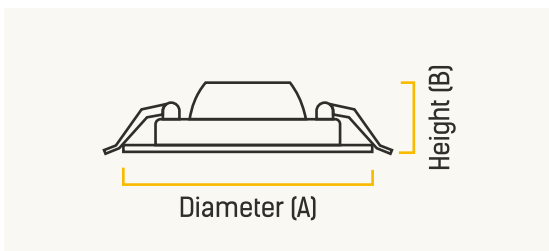

WATTAGE (W)	DIAMETER (A)	HEIGHT (B)	CUTOUT (C)(ø)
3	93 mm	28 mm	75 mm
6	118 mm	28 mm	100 mm
10	142 mm	28 mm	125 mm
15	168 mm	28 mm	150 mm
20	218 mm	28 mm	200 mm



APPLICATIONS



BED ROOM



LIVING ROOM



KITCHEN

GARNET WAVE SLIM SQUARE PANEL LIGHT



- Brightest edge lit panels with efficacy upto 100lm/W
- Slim and decorative design adds to home décor
- Aluminium heat sink for effective heat dissipation
- Anti glare LGP technology, safe for eyes
- LM 80 tested SMD LED technology
- Integrated driver with high voltage protection upto 380VAC
- Surge protection upto 2.5 KV



Warm White



Neutral White



Cool White



CAT NO	WATTAGE(W)	CCT(K)	LUMENS(lm)	VOLTAGE RANGE(VAC)
D720360	3	6000	237	150-300
D720340	3	4000	225	150-300
D720330	3	3000	213	150-300
D720660	6	6000	487	150-300
D720640	6	4000	462	150-300
D720630	6	3000	438	150-300
D721060	10	6000	965	150-300
D721040	10	4000	937	150-300
D721030	10	3000	890	150-300
D721560	15	6000	1468	150-300
D721540	15	4000	1425	150-300
D721530	15	3000	1353	150-300
D722060	20	6000	2058	150-300
D722040	20	4000	1960	150-300
D722030	20	3000	1862	150-300

DIMENSIONS

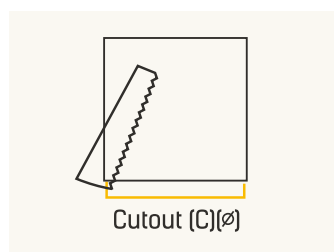
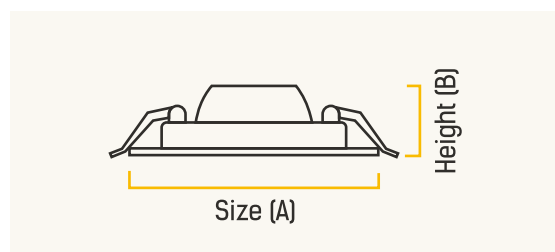

WATTAGE (W)	SIZE (A)	HEIGHT (B)	CUTOUT (C)(Ø)
3	93x93 mm	28 mm	75x75 mm
6	118x118 mm	28 mm	100x100 mm
10	142x142 mm	28 mm	125x125 mm
15	168x168 mm	28 mm	150x150 mm
20	218x218 mm	28 mm	200x200 mm



APPLICATIONS



BED ROOM



LIVING ROOM



KITCHEN



GARNET EDGE LIT 2X2 PANEL



- ↳ Elegant sleek look with 10mm thickness
- ↳ Soft & glare free light with optics designed with LGP technology
- ↳ LM 80 tested LED technology ensures long life
- ↳ High voltage protection upto 440VAC
- ↳ Surge Protection upto 4kV
- ↳ Aluminium heat sink for better thermal management



Neutral White



Cool White

CAT NO	WATTAGE(W)	CCT(K)	LUMENS(lm)	VOLTAGE RANGE(VAC)
DG14065	40	6500	4000	150-300
DG14040	40	4000	4000	150-300



DIMENSIONS

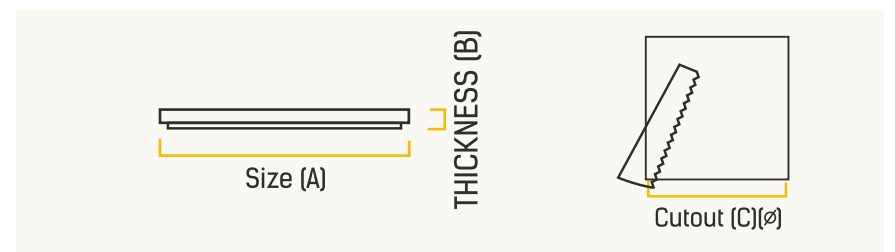

WATTAGE (W)	SIZE (A)	THICKNESS (B)	CUTOUT (C)(ø)
40	595x595 mm	32 mm	585 mm

APPLICATIONS



OFFICES



COLLEGES



SCHOOLS



HOTELS

GARNET

Backlit 2x2 Panel



- Sleek backlit design with with 100lm/W efficacy
- Aluminum heat sink provides better thermal management
- LM80 tested LED technology gives long life to LED Chips
- Soft and glare free light with dual optics is good for eyes
- Driver designed with high voltage protection up-to 440VAC
- Surge protection upto 4KV



CAT NO	WATTAGE(W)	CCT(K)	LUMENS(Lm)	VOLTAGE RANGE (VAC)
DG24065	40	6500	4000	150-300
DG24040	40	4000	4000	150-300



DIMENSIONS

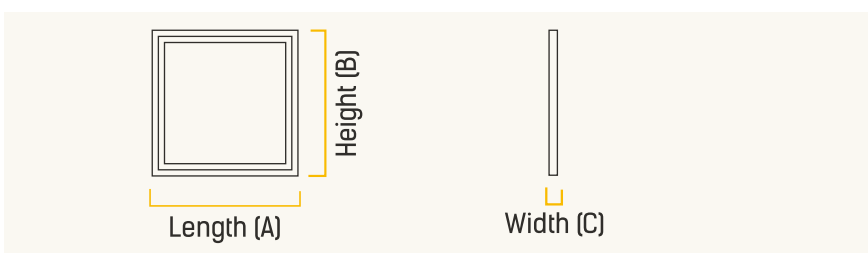

WATTAGE (W)	LENGTH (A)	HEIGHT (B)	WIDTH (C)	CUTOUT
40	595	32 mm	595	585*585

APPLICATIONS

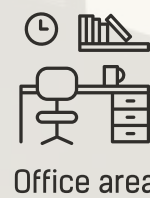

GARNET SURFACE PANELS



An exquisite range of surface mounted panels with edge-lit LEDs that provide soft, energy-efficient light that is used for ambient lighting (indoor applications). It's suitable for parking spaces, lobbies and balconies.

GARNET TRIMLESS SURFACE ROUND PANEL



- ▷ Elegant sleek look with screwless design
- ▷ Aluminium heat sink for effective heat dissipation
- ▷ Anti glare LGP technology, safe for eyes
- ▷ LM 80 tested LED technology ensures long life
- ▷ Driver with high voltage protection upto 380VAC
- ▷ Surge protection upto 2.5KV



CAT NO	WATTAGE(W)	CCT(K)	LUMENS(lm)	VOLTAGE RANGE(VAC)
D640665	6	6500	420	150-300
D640640	6	4000	390	150-300
D640627	6	2700	360	150-300
D641265	12	6500	960	150-300
D641240	12	4000	900	150-300
D641227	12	2700	840	150-300
D641865	18	6500	1440	150-300
D641840	18	4000	1350	150-300
D641827	18	2700	1260	150-300

DIMENSIONS

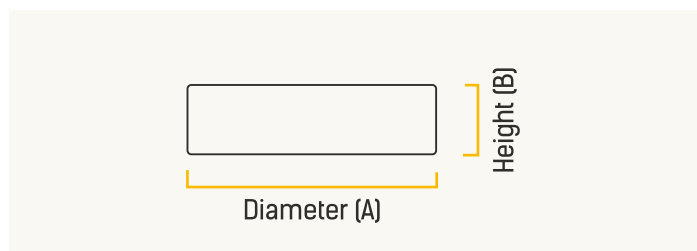

WATTAGE (W)	DIAMETER (A)	HEIGHT (B)
6	100 mm	23 mm
12	150 mm	23 mm
18	200 mm	23 mm



APPLICATIONS



GARNET TRIMLESS SURFACE SQUARE PANEL



- ↳ Elegant sleek look with screwless design
- ↳ Aluminium heat sink for effective heat dissipation
- ↳ Anti glare LGP technology, safe for eyes
- ↳ LM 80 tested LED technology ensures long life
- ↳ Driver with high voltage protection upto 380VAC
- ↳ Surge protection upto 2.5KV



Warm White



Neutral White



Cool White



CAT NO WATTAGE(W) CCT(K) LUMENS(lm) VOLTAGE RANGE(VAC)

D650665	6	6500	420	150-300
D650640	6	4000	390	150-300
D650627	6	2700	360	150-300
D651265	12	6500	960	150-300
D651240	12	4000	900	150-300
D651227	12	2700	840	150-300
D651865	18	6500	1440	150-300
D651840	18	4000	1350	150-300
D651827	18	2700	1260	150-300

DIMENSIONS

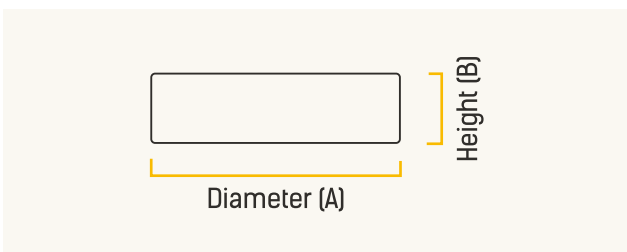

WATTAGE (W)	SIZE (A)	HEIGHT (B)
6	100x100 mm	23 mm
12	150x150 mm	23 mm
18	200x200 mm	23 mm



APPLICATIONS



MODERN HOMES



HOSPITALITY



LOBBY



PARKING



GARNET RIMLESS SURFACE PANEL



- ↳ Elegant and rimless designed panel with minimum thickness
- ↳ Pressfit mechanism for easy installation
- ↳ LM80 tested LED technology ensures long life
- ↳ Driver with high voltage protection upto 400V
- ↳ Surge protection upto 3.5KV



Warm White



Neutral White



Cool White

CAT NO	WATTAGE(W)	LUMENS(lm)	CCT(K)	VOLTAGE RANGE(VAC)
DD10665	06	650	6500	150-300
DD10640	06	570	4000	150-300
DD10627	06	540	2700	150-300
DD11265	12	1200	6500	150-300
DD11240	12	1140	4000	150_300
DD11227	12	1080	2700	150-300
DD11865	18	1800	6500	150-300
DD11840	18	1710	4000	150-300
DD11827	18	1620	2700	150-300
DD12465	24	2400	6500	150 300
DD12440	24	2280	4000	150-300
DD12427	24	2160	2700	150-300

DIMENSIONS

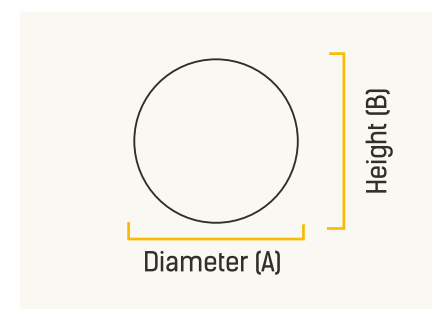

WATTAGE(W)	DIAMETER(A)	HEIGHT(B)
06	90	27
12	120	27
18	155	27
24	190	27

APPLICATIONS



MODERN HOMES



HOSPITALITY



LOBBY



PARKING



GARNET RIMLESS SURFACE PANEL



- ↳ Elegant and rimless designed panel with minimum thickness
- ↳ Pressfit mechanism for easy installation
- ↳ LM80 tested LED technology ensures long life
- ↳ Driver with high voltage protection upto 400V
- ↳ Surge protection upto 3.5KV



Warm White



Neutral White



Cool White

CAT NO	WATTAGE(W)	LUMENS(lm)	CCT(K)	VOLTAGE RANGE(VAC)
DD20665	06	650	6500	150-300
DD20640	06	570	4000	150-300
DD20627	06	540	2700	150-300
DD21265	12	1200	6500	150-300
DD21240	12	1140	4000	150-300
DD21227	12	1080	2700	150-300
DD21865	12	1800	6500	150-300
DD21840	18	1710	4000	150-300
DD21827	18	1620	2700	150-300
DD22465	24	2400	6500	150-300
DD22440	24	2280	4000	150-300
DD22427	24	2160	2700	150-300

DIMENSIONS

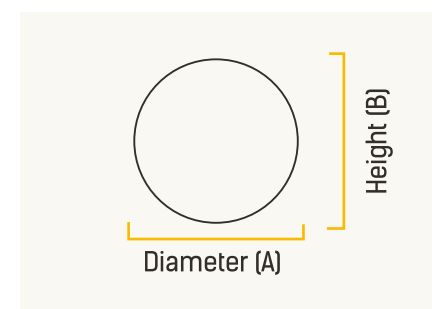

WATTAGE(W)	DIAMETER(A)	HEIGHT(B)
06	90	27
12	120	27
18	155	27
24	190	27

APPLICATIONS



MODERN HOMES



HOSPITALITY



LOBBY



PARKING

GARNET BATTENS



wipro

wipro

wipro

wipro

The Garnet Batten compliments the décor of your home, and provides uniform lighting for your drawing room, kitchen and bedrooms. What's more it is packaged in a slim body with decorative endcaps

GARNET BATTEN



- High brightness design with more than 100 lm/W efficacy
- Slim design with decorative end caps
- High performance diffuser for soft and glare free light
- LM 80 tested LED technology ensures long life
- Driver with high voltage protection upto 440V
- Surge protection upto 4KV



Warm White



Neutral White



Cool White

CAT NO	WATTAGE(W)	CCT(K)	LUMENS(lm)	VOLTAGE RANGE(VAC)
D530565	5	6500	500	150-300
D530527	5	2700	450	150-300
D531065	10	6500	1000	150-300
D531027	10	2700	900	150-300
D532065	20	6500	2000	150-300
D532040	20	4000	1800	150-300
D532027	20	2700	1800	150-300
D532265	22	6500	2400	150-300
D532227	22	2700	2200	150-300
D532665	26	6500	2600	150-300

DIMENSIONS

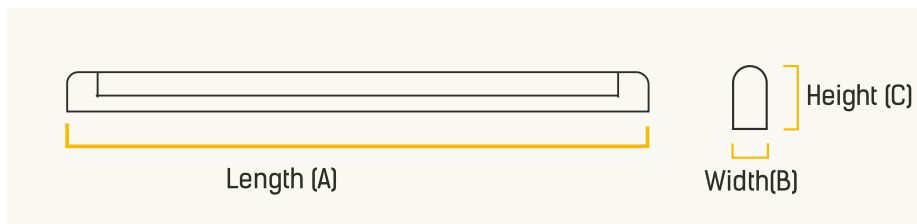

WATTAGE (W)	LENGTH (A)	WIDTH (B)	HEIGHT (C)
5	266 mm	25mm	40 mm
10	536 mm	25 mm	40 mm
20	1136 mm	27 mm	40 mm
22	1136 mm	27 mm	40 mm
26	1136mm	27mm	40mm

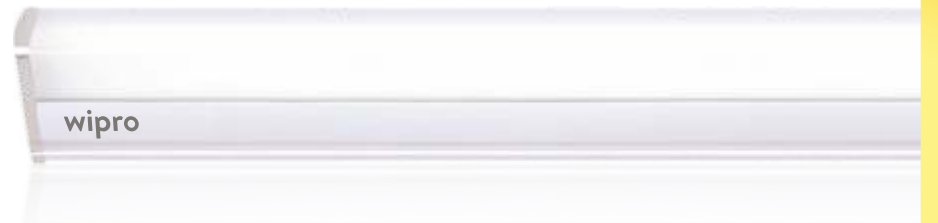

APPLICATIONS



BED ROOM



LIVING ROOM



KITCHEN



OFFICE



PARKING



GARNET TUBE LIGHT



- ↳ Driver with high voltage protection upto 38
- ↳ Wide light distribution with 300° beam angle
- ↳ Robust design with effective heat dissipation
- ↳ LM 80 tested SMD LED technology
- ↳ Wide voltage manage 150-300 VAC
- ↳ HV protection upto 440V & and surge protection upto 4kV



Warm White



Cool White

CAT NO	WATTAGE(W)	CCT(K)	LUMENS(lm)	BASE CAP	CONNECTION
D642065	20	6500	2000	G13	Single End
D622065	20	6500	2000	G13	Double End

DIMENSIONS

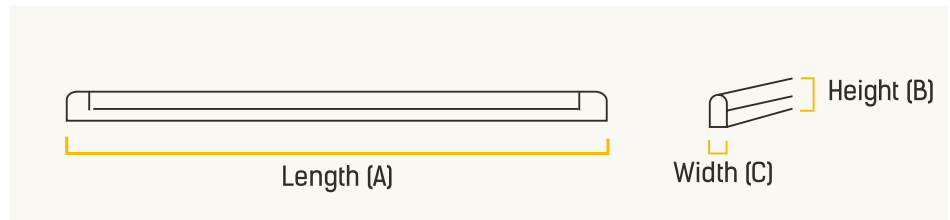

WATTAGE (W)	LENGTH (A)	HEIGHT (B)	WIDTH (C)
20	1200 mm	44 mm	29 mm

GARNET NR LAMP (4 pin 2G11)



- ↳ Retrofit to existing 36W CFL NR lamp
- ↳ Glare free light with polycarbonate diffuser
- ↳ Optics designed for wide light distribution
- ↳ LM 80 tested LED technology ensures long life
- ↳ Driver with HV protection upto 380V & surge protection upto 2.5V

CAT NO	WATTAGE (W)	CCT (K)	LUMENS (lm)	VOLTAGE (VAC)
D611865	18	6500	1800	150-300

APPLICATIONS



BED ROOM



LIVING ROOM



KITCHEN



OFFICE



PARKING

GARNET LINEAR CABINET LIGHT



- ↳ Sleek Linear Lights, suitable for Kitchen cabinets, wardrobes, Working desk
- ↳ Inbuilt driver with high voltage protection upto 380V and 2.5kV Surge Protection
- ↳ Glare free soft light with milky diffuser, good for eyes
- ↳ LM80 tested LED technology ensures long life

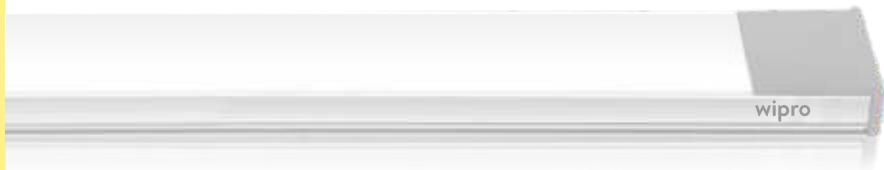

CAT NO	WATTAGE (W)	CCT(K)	LUMENS (lm)	VOLTAGE RANGE (VAC)
DJ10527	5	2700	370	220-240
DJ10540	5	4000	380	220-240
DJ10565	5	6500	400	220-240
DJ11027	10	2700	780	220-240
DJ11040	10	4000	790	220-240
DJ11065	10	6500	800	220-240
DJ11627	16	2700	1200	220-240
DJ11640	16	4000	1250	220-240
DJ11665	16	6500	1300	220-240



APPLICATIONS

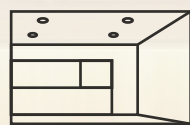

INDOOR

DIMENSIONS



WATTAGE (W)	LENGTH (A)	WIDTH (C)	HEIGHT (B)
5	290mm	17mm	8mm
10	580mm	17mm	8mm
16	853mm	17mm	8mm

GARNET ALUMINIUM BATTEN



- More than 100 lm/W Efficacy with LM80 Tested LED Technology
- Effective heat dissipation with Aluminum Extruded Heat Sink
- Non-Yellowing and high efficiency polycarbonate diffuser
- Wide beam angle of 120° and glare free light
- 4kV Surge and 440V high voltage protection
- Suitable for commercial, industrial and retail applications



Warm White



Cool White

CAT NO	WATTAGE(W)	CCT(K)	LUMENS(lm)	VOLTAGE RANGE(VAC)
D552065	20	6500	2000	150-300
D533665	36	6500	4000	150-300



DIMENSIONS

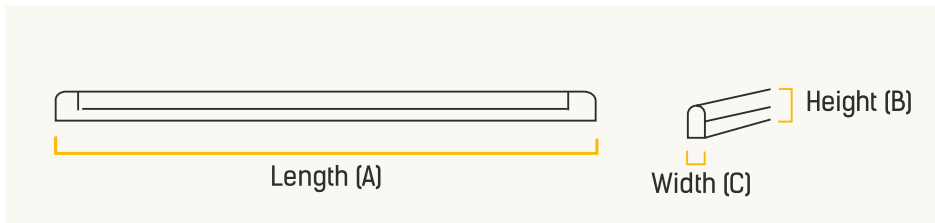

WATTAGE (W)	LENGTH (A)	HEIGHT (B)	WIDTH (C)
20	1136 mm	38 mm	23 mm
36	1180 mm	38 mm	27 mm



APPLICATIONS



OFFICE



SCHOOL



INDUSTRY



RETAIL

GARNET PLUS COLOR CHANGING BATTEN



- Changes color between 2700K - 6500K with click of switch
- Slim design with decorative end cap
- High performance diffuser for soft and glare free light
- LM 80 tested high brightness LED technology
- Driver with high voltage protection upto 440V
- Surge protection upto 4kV

CAT NO	WATTAGE (W)	CCT (K)	LUMENS (lm)	VOLTAGE RANGE (VAC)
D532200	22	6500/4000/2700	2200	150-300



DIMENSIONS

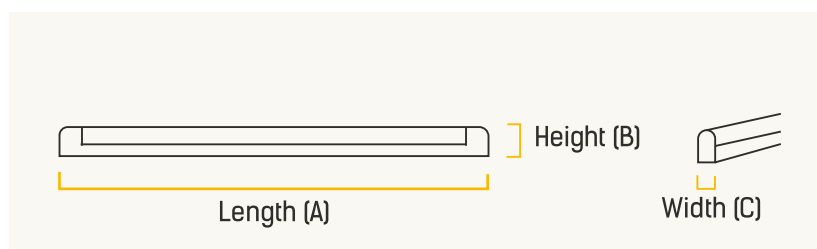

WATTAGE (W)	LENGTH (A)	HEIGHT (B)	WIDTH (C)
22	1136 mm	34 mm	28 mm

APPLICATIONS



BED ROOM



LIVING ROOM



OFFICE

GARNET BULBS



Enhance your interiors with our everyday lighting solution designed to lower your energy bills.



ECO FRIENDLY

Zero mercury content makes the disposal easy

GARNET HIGH WATTAGE BULB



- High brightness LED with efficacy upto 100lm/W
- Aluminium die cast body ensures effective heat dissipation
- Wide coverage with 240° beam angle
- LM 80 tested LED technology ensures long life
- High voltage protection upto 440V
- Surge protection upto 4kV
- Suitable for commercial and industrial application



Cool White



Base Cap

CAT NO WATTAGE(W) CCT(K) LUMENS(lm) BASE CAP VOLTAGE RANGE(VAC)

N30101	30	6500	3000	B22	150-300
N40001	40	6500	4000	B22	150-300
N50201	50	6500	5000	B22	150-300

TEJAS BULB



- High brightness LED with efficacy upto 100lm/W
- Aluminium heat sink for better heat dissipation
- Diffuser optics for glare free light, safe for eyes
- LM 80 tested LED technology ensures long life
- High voltage protection upto 440V
- Surge protection upto 4kV



CAT NO WATTAGE(W) CCT(K) LUMENS(lm) BASE CAP VOLTAGE RANGE(VAC)

N57101	5	6500	500	B22	150-300
N77101	7	6500	700	B22	150-300
N97101	9	6500	900	B22	150-300
N12501	12	6500	1200	B22	150-300



APPLICATIONS



MODERN HOMES



LIVING ROOM



STUDY ROOM



KITCHEN



OFFICES

GARNET BULB



- High brightness LED with efficacy upto 100lm/W
- Wide beam angle (240°) provides good light distribution
- Aluminium heat sink for better heat dissipation
- Diffuser optics for glare free light, safe for eyes
- LM 80 tested LED technology ensures long life
- High voltage protection upto 440VAC
- Surge protection upto 4KV



Warm White



Cool White



Base Cap



Base Cap

CAT NO WATTAGE(W) CCT(K) LUMENS(lm) BASE CAP VOLTAGE RANGE(VAC)

N32001	3	6500	315	B22	150-300
N32002	3	2700	255	B22	150-300
N56101	5	6500	525	B22	150-300
N56102	5	2700	450	B22	150-300
N76101	7	6500	735	B22	150-300
N76102	7	2700	630	B22	150-300
N96101	9	6500	945	B22	150-300
N96102	9	2700	810	B22	150-300
N12001	12	6500	1260	B22	150-300
N12002	12	2700	1080	B22	150-300
N14001	14	6500	1470	B22	150-300
N14002	14	2700	1260	B22	150-300
N18001	18	6500	1890	B22	150-300
N18002	18	2700	1620	B22	150-300
N26001	26	6500	2600	B22	150-300

N33001	3	6500	315	E27	150-300
N33002	3	2700	250	E27	150-300
N56201	5	6500	525	E27	150-300
N56202	5	2700	450	E27	150-300
N76201	7	6500	735	E27	150-300
N76202	7	2700	630	E27	150-300
N96201	9	6500	945	E27	150-300
N96202	9	2700	810	E27	150-300
N12201	12	6500	1260	E27	150-300
N12202	12	2700	1080	E27	150-300
N14201	14	6500	1470	E27	150-300
N14202	14	2700	1260	E27	150-300

APPLICATIONS



MODERN HOMES



LIVING ROOM



STUDY ROOM



KITCHEN



OFFICES

GARNET 3D BULB & BEAMER



- Wide beam angle provides glare free & wide spread of light
- Lm80 tested LED Technology for long life
- 100-300VAC wide voltage range provides fluctuation free light
- Driver with 440V High Voltage and 4kV surge protection



Cool White



Base Cap

CAT NO	WATTAGE(W)	CCT(K)	LUMENS(lm)	VOLTAGE RANGE(VAC)
N11011	10	6500	1050	150-300
N11211	12	6500	1260	150-300
N11811	18	6500	1890	150-300
N11811	20	6500	2100	150-300
N12611	26	6500	2600	150-300



APPLICATIONS



LIVING ROOM



BED ROOM



HALL



WASHROOM

GARNET FILAMENT LED BULB



Enhance your interiors with our everyday lighting solution designed to lower your energy bills.

Filament LED
Technology





GARNET CANDLE BULB



- High brightness LED with efficacy upto 100lm/W
- Clear optics to provide sparkling effect
- Diffuser optics to provide glare free light
- LM 80 tested LED technology ensures long life
- High voltage protection upto 440VAC
- Surge protection upto 4KV
- Ideal for chandeliers



2700K
Warm White



6500K
Cool White



E27
Base Cap



E14
Base Cap

CLEAR CANDLE BULB

CAT NO WATTAGE(W) CCT(K) LUMENS(lm) BASE CAP VOLTAGE RANGE(VAC)

N31002	3	2700	270	E27	150-300
N55002	5	2700	450	E27	150-300

N30002	3	2700	270	E14	150-300
N54002	5	2700	450	E14	150-300

FROSTED CANDLE BULB

CAT NO WATTAGE(W) CCT(K) LUMENS(lm) BASE CAP VOLTAGE RANGE(VAC)

N35001	3	6500	300	E27	150-300
N35002	3	2700	270	E27	150-300
N53001	5	6500	450	E27	150-300
N53002	5	2700	400	E27	150-300

N34001	3	6500	300	E14	150-300
N34002	3	2700	270	E14	150-300
N52001	5	6500	500	E14	150-300
N52002	5	2700	450	E14	150-300

APPLICATIONS



MODERN HOMES



LIVING ROOM



BED ROOM



POOJA ROOM



GARNET PROFILE STRIP LIGHT



- Profile strip with uniform brightness across length
- High Lumen output with efficacy more than 100lm /W
- Lm80 tested LED technology gives long life to LED Chips
- Easy to cut and join
- Double side copper layer for efficient flow of current

CAT NO	WATTAGE (W)/mtr	CCT(K)	LED/Meter	Voltage(VDC)
DF22827	10	2700	120	12
DF22840	10	4000	120	12
DF32827	14	2700	168	12
DF32840	14	4000	168	12
DF42827	16	2700	240	12
DF42840	16	4000	240	12

2835 STRIP LIGHT

CAT NO	LED TYPE	CCT (K)	WATTAGE (W/5mtr)	VOLTAGE (DC)
D42865-1	2835	6500	25	12
D42840-1	2835	4000	25	12
D42827-1	2835	2700	25	12
D42880-1	2835	BLUE	25	12

APPLICATIONS

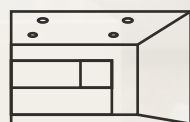

INDOOR

GARNET IP65 RATED STRIP LIGHT



- Flexible & Customizable design as per requirement
- LM80 tested LED technology for long life
- Inbuilt 220V LED driver with 3KV surge protection
- Good quality PCB for efficient flow of current
- IP65 protection for outdoor application



LED COUNT 120 per mtr

CAT NO	WATTAGE	CCT (K)	LENGTH (M)	Voltage
DF52865	6.5	6500	50	150-300
DF52827	6.5	2700	50	150-300
DF52880	6.5	BLUE	50	150-300
DF52890	6.5	RED	50	150-300
DF52895	6.5	GREEN	50	150-300
DF52885	6.5	PINK	50	150-300
DF92827	6.5	2700	100	150-300



IP 65 NEON STRIP



CAT NO	WATTAGE (W)/mtr	CCT (K)	Length	Voltage
DF82827	6.5W/M	2700	50 Mtr	150-300
DF82890	6.5W/M	Red	50 Mtr	150-300
DF82880	6.5W/M	Blue	50 Mtr	150-300

GARNET LED STRIP DRIVER



CAT NO	I/P VOLT (VAC)	OUTPUT CURRENT (Amp)	O/P VOLT (VDC)	DIMENSIONS (mm)
H43520	220-240	2	12	77x44
HD1200	220-240	2	12	80x30
HD1500	220-240	5	12	150x45
HD1600	220-240	6	12	150x45
HF10000 (IP 65 Strip)	220-240	1.6	198	145x60
HF11000 (Neon Strip)	220-240	1.6	198	145x60



APPLICATIONS

FACADE

DECORATION

LANDSCAPE



GARNET BULKHEAD



- ↳ Elegant design in white finish
- ↳ High efficiency diffuser for bright light without glare
- ↳ LM 80 tested high brightness LED technology
- ↳ Driver with HV protection upto 380V
- ↳ surge protection upto 2.5KV
- ↳ IP 65 protection against dust & rain for outdoor use



Warm White



Cool White

CAT NO	WATTAGE (W)	CCT (K)	LUMENS (lm)	VOLTAGE RANGE (VAC)
DA11065	10	6500	1000	150-300
DA11027	10	2700	900	150-300

DIMENSIONS

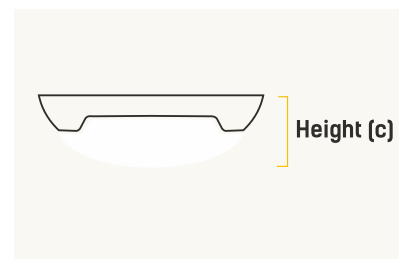
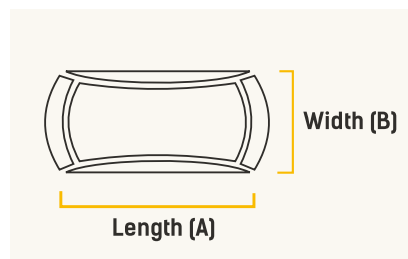

WATTAGE (W)	LENGTH (A)	WIDTH (B)	HIEGHT (C)
10	170 mm	96 mm	70 mm



GARNET SPIKE LIGHT



- ↳ Aluminium die cast body & heat sink
- ↳ LM 80 tested COB LED technology
- ↳ Surge protection of 2.5KV
- ↳ IP 65 protection from dust & rain
- ↳ Reflector technology to provide sharp beam angle & 30° optics



Warm White



Cool White

CAT NO	WATTAGE (W)	CCT (K)	LUMENS (lm)	VOLTAGE (VAC)
D930765	7	6500	480	150-300
D930727	7	2700	480	150-300

APPLICATIONS



INDUSTRY



PARKING



LANDSCAPE



BALCONY

GARNET STREET LIGHT



- High lumen output design with efficacy upto 100lm/W
- Aluminium heat sink for effective thermal management
- Lens technology for better throw of light
- LM 80 tested LED technology ensures long life
- Driver with high voltage protection upto 380VAC
- Surge protection upto 5KV
- IP 66 protection from dust & rain



CAT NO	WATTAGE (W)	CCT (K)	LUMENS (lm)	VOLTAGE RANGE (VAC)
D912065	20	6500	1900	150-300
D923065	30	6500	3000	150-300
D925065	50	6500	5000	150-300

GARNET FLOOD LIGHT



- Premium look with aluminium PDC housing
- Reflector & clear optics for sharp light
- LM 80 tested LED technology
- Driver with high voltage protection upto 380VAC
- Surge protection upto 4KV
- IP 65 protection from dust & rain



CAT NO	WATTAGE (W)	CCT (K)	LUMENS (lm)	VOLTAGE RANGE (VAC)
D913065 -1	30	6500	3000	150-300
D915065 -1	50	6500	5000	150-300
D910065 -1	100	6500	10000	150-300



APPLICATIONS

GARDEN

CANOPY

LANDSCAPE

PLAYGROUND

NOTES

A series of 20 horizontal dashed lines for writing notes.



Garnet

WIPRO LIGHTING ADVANTAGE

Wipro Lighting is a name one can trust for a revolutionary lighting system. Its environmental-friendly philosophy and consumer-centric technology makes it a class apart in the field of lighting. As a trusted brand in the lighting industry,

Wipro Lighting has lit 55% of the certified Green Buildings and Platinum-rated Green Buildings in India. With its comprehensive and innovative range of LEDs, it is taking lighting to a whole new level. Covering both retail and commercial spaces, every product of Wipro LEDs offers the perfect light output to enhance your productivity. With its aesthetics, each unique product is designed to beautify your home and office space with the right kind of mood. Our product designs have received recognition such as the prestigious India Design Mark Award as well as the European Design Award. So now, bring home the Wipro Lighting innovation and live life in a new light.

Wipro Enterprises (P) Limited

Registered office: #8, Wipro House, 80 Ft Road, Koramangala, Bengaluru-560 034, KA.

Write to: Wipro Consumer Care, #8, Wipro House, 80 Ft Road, Koramangala, Bengaluru-560 034, KA

Email us at: feedback.wcc@wipro.com | **Call toll free no:** 1800-425-1969

Visit us at: www.wiproconsumerlighting.com | www.wiprolighting.com | www.wiproconsumercare.com

 facebook.com/WiproLED

 twitter.com/WiproLED

 instagram.com/WiproLED